

The Wireless Constructor

6^D
MONTHLY



EDITED BY
PERCY W. HARRIS, M. I. R. E.

Vol. II

AUGUST, 1926

No. 10

The "DAVLOW THREE"

By

W. Q. KAY





**A NEW 2 VOLT VALVE
WITH THE WONDERFUL P.M. FILAMENT**

Superior to many 6-volt valves and has up to three times greater emission surface.
 Gives better results than any other 2-volt valve in all stages of a receiving set.
Makes each accumulator charge last three times as long.
 Embodies the special patented P.M. Filament that cannot be broken except by the very roughest handling.
 Is so economical that no sign of glow can be discerned.

THE P.M.1 15/6

(For H.F., Detector and L.F. Operation—2 volts—One-Tenth Ampere)

GET ONE FROM YOUR RADIO DEALER.

Ask for particulars of the P.M. Series for 2, 4 and 6 Volts.

Mullard
THE • MASTER • VALVE

ADVT. THE MULLARD WIRELESS SERVICE CO., LTD., BALHAM, LONDON, S.W.12.

The WIRELESS CONSTRUCTOR

— Edited by Percy W. Harris —

Vol. II. No. 10

CONTENTS

AUGUST

The "Dawlow Three"	879	"The Simplicity Five"	914
By W. Q. KAY.		Do You Keep a Crystal Check?	916
Making the Best Use of Your Environment	886	Talks to Beginners—V.	919
By A. V. D. HORT, B.A.		By PERCY W. HARRIS, M.I.R.E., Editor.	
Australia on Two Valves	889	Try These New Selective Circuits	922
By PERCY W. HARRIS, M.I.R.E., Editor.		Was the Designer Wrong?	927
In Scandinavia with a Superhet.	894	Have You Made Your Portable Set?	931
By Capt. L. F. PLUGGE.		By D. J. S. HARTT, B.Sc.	
Change Your Coil and Change Your Circuit	901	Workshop Hints	939
By STANLEY G. RATTEE, M.I.R.E.		An All-Purpose Valve Unit	942
Some Hints for the Short-Wave Beginner	909	By L. H. THOMAS (6QB)	
By G. T. KELSEY.		Points to Watch in Coil Holders.	948
		By H. J. BARTON-CHAPEL, Wh. Sch., B.Sc., A.C.G.I., D.I.C., A.M.I.E.E.	
		Apparatus Tested	953



A Guaranteed Condenser at a Popular Price!

THE popular price of this new condenser of unrivalled precision presents to the amateur the ideal instrument for his experimental set. The construction, executed for mechanical perfection, has been achieved by the use of a ball-bearing rotor, eliminating harshness and unreliability of tuning.

Electrical efficiency and exceptional range of wave length together with full dial availability for tuning, is combined with its low loss square law design.

If at any time the Bowyer-Lowe Condenser develops a fault during the twelve months after purchase, the article will be replaced free of charge.

Instal this instrument now.

Write for descriptive leaflet free on application to
The BOWYER-LOWE Co., Ltd.,
 LETCHWORTH.



ANNOUNCEMENT BY THE BOWYER-LOWE CO. LTD.
 LETCHWORTH HERTS

The Bowyer-Lowe POPULAR Condenser

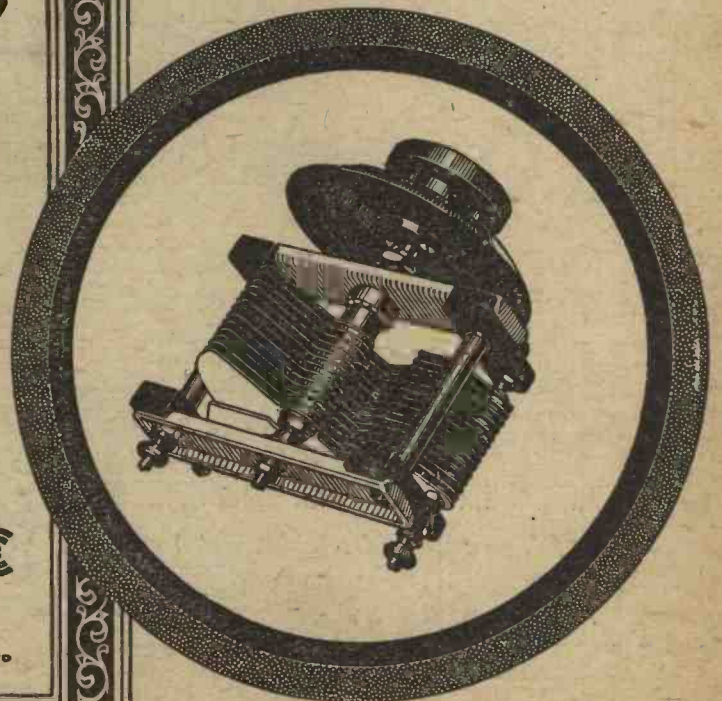

MORE FACTS ABOUT L.F. TRANSFORMERS

The simplified expression giving the amplification ratio of valve and L.F. transformer is:—

$$\mu \times \sqrt{\frac{Z^2}{R^2 + Z^2}}$$

where μ is the amplification factor of the valve.

"Z" is the impedance of the transformer.

"R" is the impedance of the valve.

If, at a given frequency, the valve impedance "R" equals the transformer impedance "Z," the expression becomes $\div \mu \times \sqrt{\frac{1}{2}}$ or $\mu \times 0.7$.

On the other hand, the greater the transformer impedance "Z" the more nearly does the expression become equal to $\div \mu \times \sqrt{1}$ or $\mu \times 1$.

Thus, the greater the transformer impedance the greater the amplification ratio, and to choose a transformer of lower impedance to match the impedance of the valve merely results in impairing the amplification.

Therefore, to obtain the best results choose a transformer of very high impedance, and, seeing that transformer impedance varies with frequency whilst valve impedance is practically unaffected by frequency, choose a transformer which has high impedance at low frequency, say 100; otherwise, low notes will not be reproduced satisfactorily.



BRITISH MADE L.F. TRANSFORMERS TYPE AF3

HAVE THE FOLLOWING IMPEDANCES

At 100 Periods - - - 50,000 OHMS
At 500 Periods - - - 410,000 OHMS

**NO BETTER TRANSFORMER
IS AVAILABLE AT ANY PRICE**

Ask your Dealer for Leaflet Wa401

FERRANTI Ltd. HOLLINWOOD, LANCASHIRE.



25/-

**RATIO 3.5 to 1
FOR USE IN BOTH
FIRST AND SECOND
STAGES.**



Published by Radio Press, Ltd., Bush House, Strand, W.C.2. 'Phone : City 9911.

THE "DAVLOW THREE"

By W. Q. KAY

Do you find it a nuisance to have to pull out coils and insert others when you want to change over from Daventry to a low-wave station? On this attractive set you simply move a single switch and the change-over is complete.

FOR simplicity of operation and construction the straightforward 3-valve receiver, comprising a detector valve followed by two note magnifiers, is a very useful arrangement. The selectivity which can be obtained with such a circuit is, of course, not high, although with some care it can be made reasonably good.

Such a circuit, therefore, is a useful one for what one may term "hack" reception of the local station with occasional listening to more distant programmes. At the same time, if the instrument is to be used for such everyday work, other features are desirable.

Two or Three Valves

In the first place, the reception of the local station can be obtained satisfactorily on the loud-speaker on two valves only at distances of ten or twelve miles. It is desirable, therefore, to be able to cut out the last valve if possible, and arrangements have been made for this to be done in this particular receiver. Should it be desired to produce very loud volume at any time, such, for example, as provision of music for outdoor dancing on the lawn or some such arrangement, the purity of the music is of particular importance. For this reason the last valve has been made resistance-

coupled and has been arranged to be switched in or out of circuit at will by means of ordinary jack switches.

The other feature which is very desirable in any receiver of this type is the reception of Daventry and possibly other programmes on this wave-band without the necessity for changing coils. A simple change-over

The Circuit

The circuit adopted is a simple Reinartz arrangement. Various other types of detector circuits were experimented with, but the circuit giving the best results both as regards simplicity of operation, selectivity, and freedom from interaction between the two coils was our old friend the Reinartz arrangement. A simple change-over switch enables the wavelength range to be changed at will, and the remainder of the circuit is straightforward.

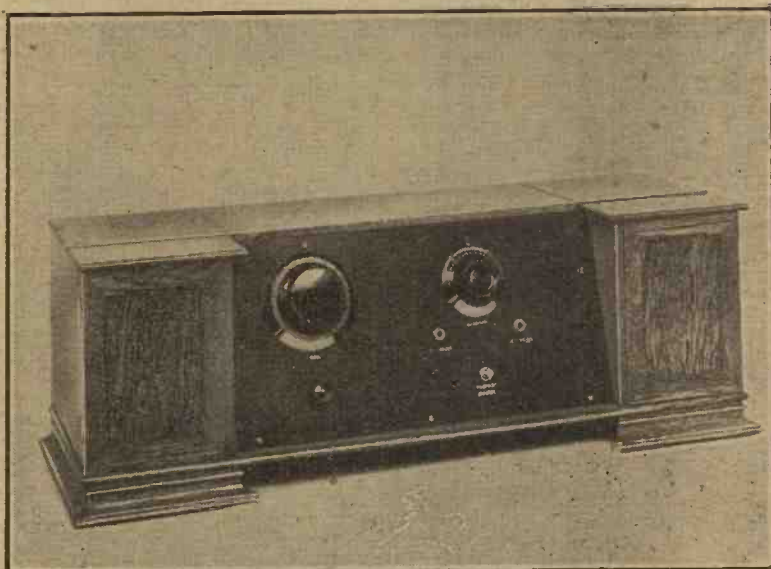

There is only one tuning dial on the set (the large one), the knob of the wave-change switch being placed immediately beneath it.

switch has been used in this set, therefore, whereby the circuit may be changed over from the one set of coils to the other, and for this reason the receiver has been called the "Davlow," giving Daventry or the local station with equal facility.

Self-Contained Batteries

Still pursuing the policy of making the receiver a true hack model, always ready and giving as little trouble as possible, arrangements have been made to house the L.T. and H.T. batteries in the cabinet. This enables us to obtain a very handsome type of layout, as will be seen from the photographs.

There are two battery compartments, one at each end of the cabinet, while the set is mounted on a slightly sloping panel which is placed in between the two battery compartments. It will be seen that this provides a neat and attractive arrangement, the receiver being self-contained except for the aerial and earth, thereby avoiding a good deal

The "Davlow Three"

of the trouble usually occasioned by the batteries and their attendant connections.

Layout

The layout of the components in the receiver itself has been made somewhat compact. The high-frequency circuit has of necessity to occupy a certain space in order to avoid interaction between the coils. Secondly, the use of a sloping panel always tends to provide a certain waste space which cannot normally be utilised.

- One Interchangeable H.F. choke with holder (Bowyer-Lowe Co., Ltd.).
- One wire-wound anode resistance, 60,000 ohms (Varley).
- One .01 fixed condenser, type 620 (Dubilier).
- One .0003 condenser type 600 with grid-leak clips (Dubilier).
- One 2-megohm leak (Dubilier).
- One .25 megohm leak in holder (Dubilier).
- Three fixed resistors to suit the valves in use with sockets.

One packet of Radio Press panel transfers.

Bevelling the Panel

The first operation is the fitting of the panel into position. The base-board provided with the cabinet will be found to have one edge bevelled. The two long edges of the panel must also be bevelled at the same angle, so that when the panel is screwed on to the baseboard and is resting at its proper slope the bottom will lie flush

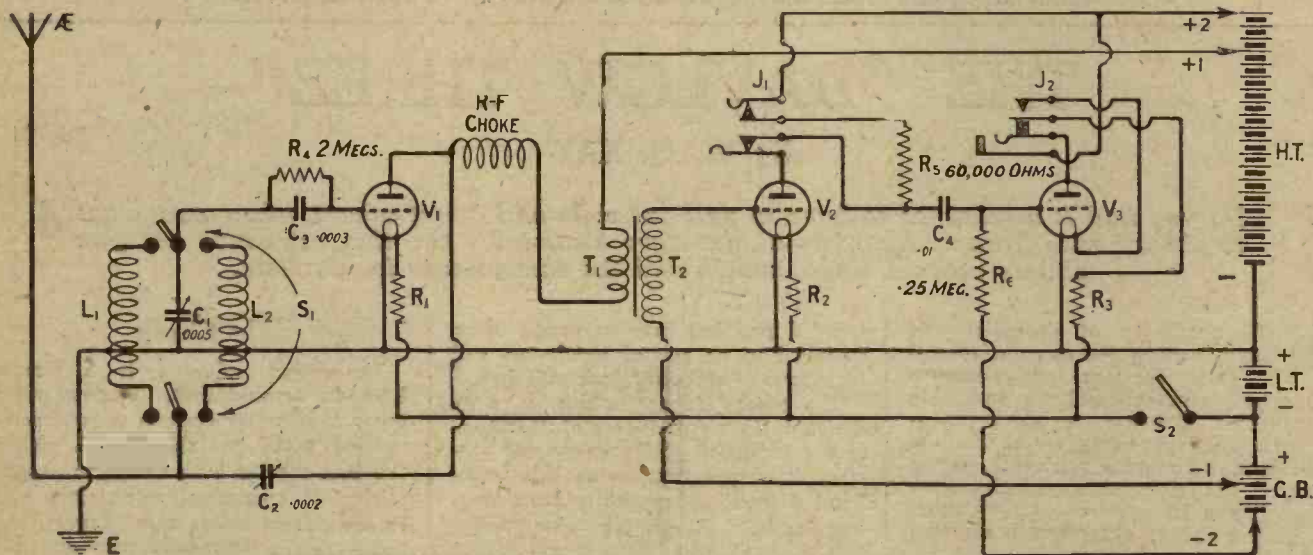

Fig. 1.—The circuit is a straightforward Reinartz arrangement. The switch S1 serves to make the change from one wave range to another.

In order to avoid making the receiver any larger than necessary, therefore, a somewhat unusual layout has been incorporated.

The two coils with the tuning condenser and switching arrangement are housed on the left-hand side of the receiver. The first note magnifier, which is transformer-coupled, is housed at the rear of the baseboard on the right-hand side, while the other note magnifier, resistance-coupled and capable of being switched in or out at will, is at the front of the baseboard underneath the lee of the sloping panel. The circuit thus runs round three sides of the square, but no detrimental effect is obtained from such proceeding.

You will require the following components:—

- One special "Davlow" cabinet (Pickett Bros.).
- One ebonite panel 16 in. by 8 in. by ½ in. (Clayton Rubber Co., Ltd.).
- One .0005 variable condenser (Cleartron Dikast).
- One 4-in. dial to fit the condenser (Cylidon).
- One .0002 variable condenser (Jackson Bros.).
- One Patent low-frequency transformer, first stage (Igranic Electrical Co., Ltd.).

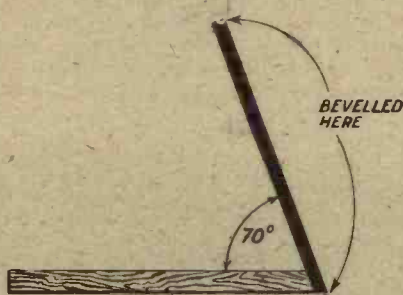

Fig. 2.—The panel is attached to the baseboard at an angle of 70 degrees.

- Three vibratory valve holders (Etherplus).
- One "On-off" switch (Igranic Electric Co., Ltd.).
- One double-circuit jack (Bowyer-Lowe Co., Ltd.).
- One two-pole change-over switch (Efesca).
- One filament switching jack (Bowyer-Lowe Co., Ltd.).
- One ebonite strip 3 in. by ½ in. by ¼ in., carrying two terminals.
- One 2-in. length of 2-in. diameter ebonite tube.
- One 4-in. length ditto.
- Quantity of Glazite wire and flex wire.

upon the cabinet and the top edge will be horizontal. This will be clear from the diagram shown in Fig. 2, which indicates how this bevelling has been carried out.

In order to fix it the best method is to hold the ebonite in a suitable wood-working vice and to bevel the edges with long, slow movements of a file. Care must, of course, be taken to get the bevel uniform all along. If a wood-working vice is not available then the ebonite should either be clamped on to a table or be held by some other means, when the bevelling can be carried out just as usual, the filing in this case being carried out horizontally.

The Panel Components

Having finished the bevelling, the panel should be screwed to the baseboard with three screws and inserted in the cabinet to make sure that it fits accurately. When this has been accomplished the panel may be unscrewed again and then drilled to take the two condensers, the two jacks, and the filament switch into the positions shown. These components should then be mounted in the correct positions. The only component requiring any attention is the reaction condenser, which, as will be seen, is

A "Quick-Change" Three-Valve Set

mounted at an angle so that the bottom end comes approximately between the two jacks.

Winding the Coils

Before proceeding any farther it is necessary to wind the two coils. The coil for the lower wavelengths is wound on the 2-in. former and the coil for the Daventry wave on the former 4 in. long. The windings are simple single-layer windings with a tapping at a suitable point. They can therefore be constructed without difficulty, the details of the windings being as follow:—

The Baseboard Components

Now mount the components on the baseboard in the positions shown. Although the layout has been compactly arranged there is ample room for the components, and no difficulty will be experienced in spacing the components. Before finally screwing the components into position, place the panel, with the appropriate components mounted thereon, in the position it should occupy in order to ensure that none of the panel components foul the baseboard components.

gives better access to the parts when wiring up.

The components on the panel may now be wired up. First take a lead from the centre point of one side of the switch to the reaction condenser as shown in Fig. 4. Then cut off five lengths of Glazite about 8 in. long, which should be soldered to the other connections of the change-over switch. These leads may be allowed to project at the back of the panel in such a direction that they can be connected to the coils when the panel is mounted in position. If these connections are made at this stage no difficulty should

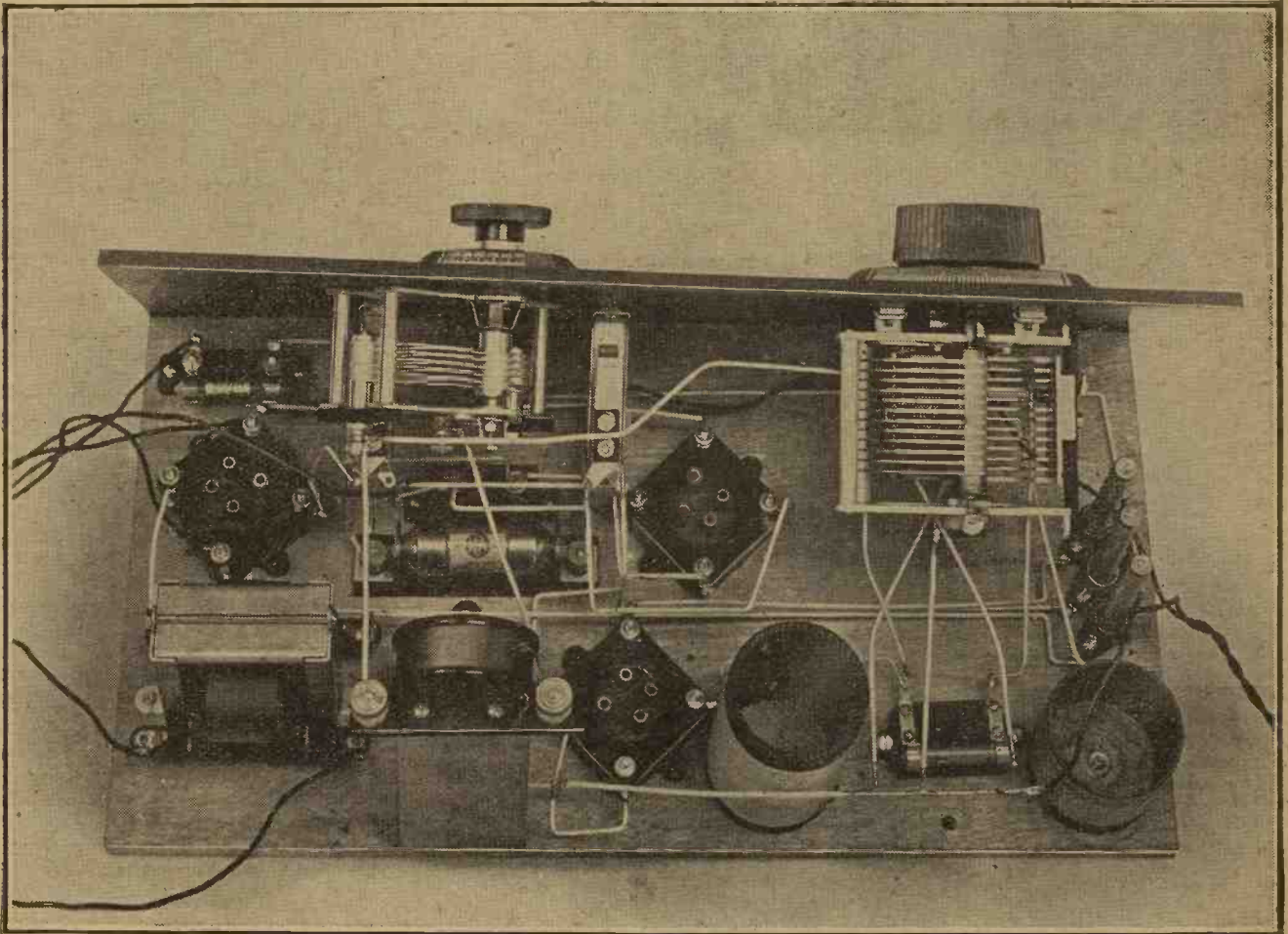

The three filament resistors are grouped together for convenience, and the coils are placed well away from any components likely to produce losses.

Low Wave Coil—70 turns of No. 30 D.S.C. wire tapped at 20 turns.

Daventry Coil—300 turns of No. 40 S.C.C. wire tapped at 50 turns.

When these coils have been wound small pieces of wood should be cut and pushed into the bottom to form bases by means of which the coils may be screwed into position on the baseboard.

These bases may either be made a tight fit or, if desired, stuck in with glue or Seccotine.

Wiring Up

The components may now be screwed down into position and the wiring up may be commenced. Wire up the components on the baseboard first of all. These connections may be completed with the exception of the leads to the jacks and the connections from the two coils to the change-over switch. It is advisable not to mount the aerial and earth terminals until later, as this

be experienced, but if they are left until later the switch is somewhat difficult of access.

The panel may now be mounted in position and the wiring completed. First connect a wire from one side of the on-off switch to the three fixed resistors. Secondly, two long flex leads should both be connected to the other terminal of the switch. One of these runs out to the left of the set and is connected to the low-tension

The "Davlow Three"

accumulator, while the other runs out to the right of the set and is connected to the G.B. positive. The jacks may now be wired in position, and little difficulty will be experienced if the wiring diagram is followed.

plus respectively, the H.T. connection going to the frame of the jack. The two inside contacts are connected to the resistance. When the plug is removed, therefore, the resistance is connected in circuit. Care must be

The left-hand jack is simpler to wire. The two bottom springs are connected to the anode and H.T., so that when the jack is in circuit the telephones or loud-speaker are connected in the anode circuit of this

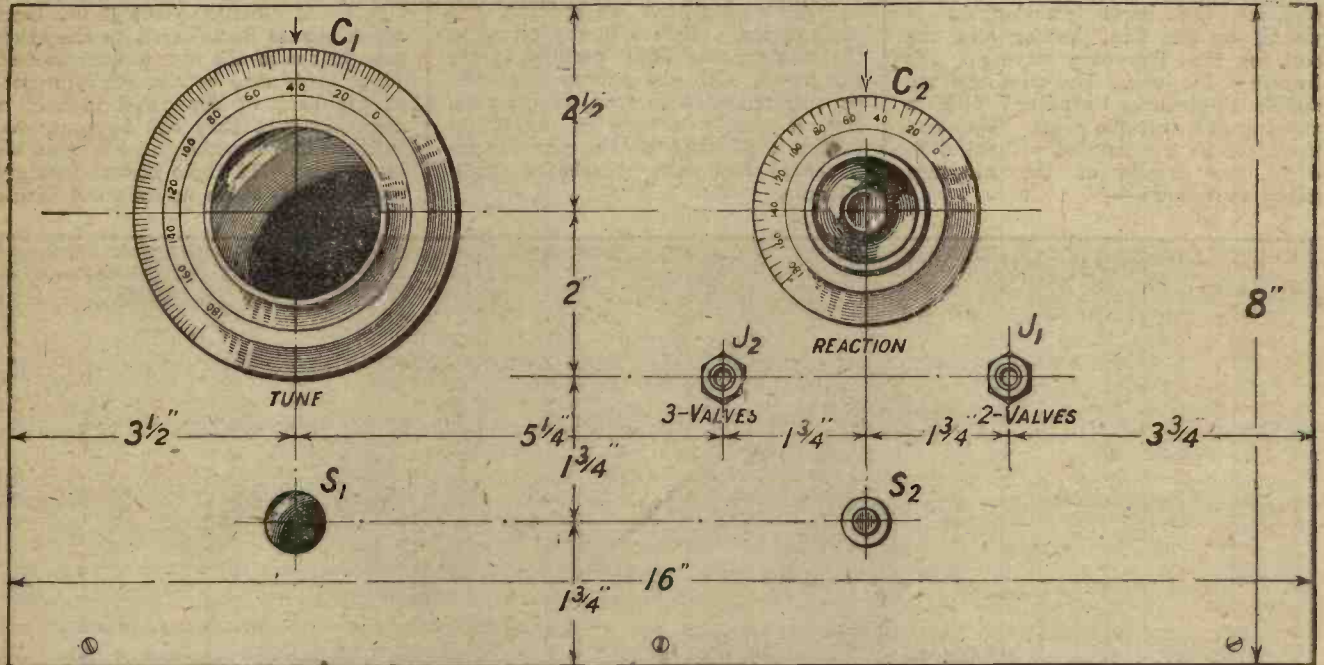

Fig. 3.—Three screws along the lower edge of the panel suffice to attach it to the baseboard.

Connecting the Jacks

The right-hand jack is a simple closed circuit jack. The outside contacts go to the anode of V_2 and H.T.

taken to see that the side of the resistance which goes to the coupling condenser is also connected to the spring making contact with the anode spring.

valve. The two top springs are connected in the filament circuit of this last valve, so that the insertion of the plug connects up the filament and so lights the valve.

Wiring the Switch

It is now necessary to make the connection from the leads coming from the change-over switch to the two coils. These may be made very simply, the leads being bent into suitable positions as shown in the wiring diagram. The centre points of the switch go to the reaction condenser and to the grid condenser respectively. On the reaction condenser side the two other connections go to the beginnings of the two coils, that is to say, the ends nearest the tappings. The other ends of the coils are connected to the grid condenser side of the switch. Care must, of course, be taken to ensure that when the switch is in any given position the connections both go to the same coil.

The aerial and earth pillar may now be mounted up. This consists of a simple ebonite strip carrying two terminals mounted on a wooden pillar, as can be seen from the diagrams and photographs. This brings the terminals up towards the top of the set, which facilitates connecting up when the set is in use. The earth terminal

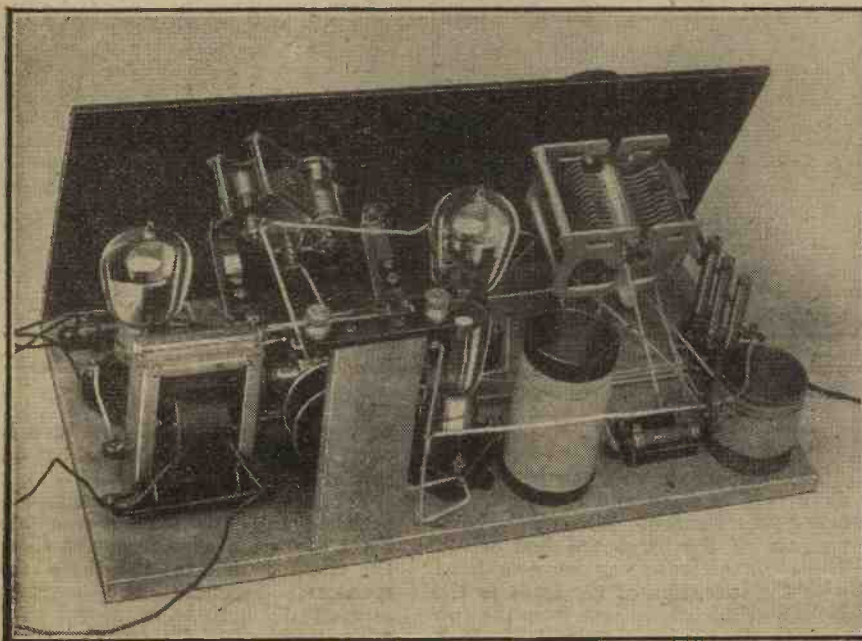

The aerial and earth terminals are mounted on an elevated platform to facilitate the connection of the necessary leads.

A Set all the Family Can Use

is connected to the negatives of all the filaments, and also to the tapping points on the two coils.

The Tuning Condenser

A lead is also taken from this point to the moving plates of the main tuning condenser, the fixed plates of this condenser being connected to the centre point of the change-over switch on the grid condenser side. Finally the aerial terminal is connected straight across to the fixed plates of the reaction condenser, this terminal also being connected to the change-over switch as has previously been described. The moving plates of this reaction condenser are connected to the anode of the detector valve.

The wiring is now completed and the

set may be tested out. Make the usual tests for correctness of wiring and to ensure that no high-tension leads are in any way connected with the filament leads. The valves may then be inserted and the batteries connected up.

Testing Out

Plug in the telephones on the two-valve position, and set the reaction condenser at minimum. Switch on the valves, when on rotating the tuning dial the local station or the Daventry Station will be heard without difficulty. Which is actually heard, of course, depends upon the position of the change-over switch. If the receiver is wired exactly in accordance with the diagrams given, then the local station will be received

with the switch pushed in and Daventry with the switch pulled out.

Having received signals, the reaction control may be tried, and it should be found that an increase of the reaction condenser causes a gradual strengthening of the signals up to the point of oscillation. The receiver must be adjusted by varying the high-tension tapping on the detector valve until the set slides smoothly into oscillation without any flopping. Any such testing must, of course, be done outside broadcast hours, to avoid any possible interference with one's neighbours.

Interchangeable Chokes

In obtaining this smooth reaction the interchangeable high-frequency

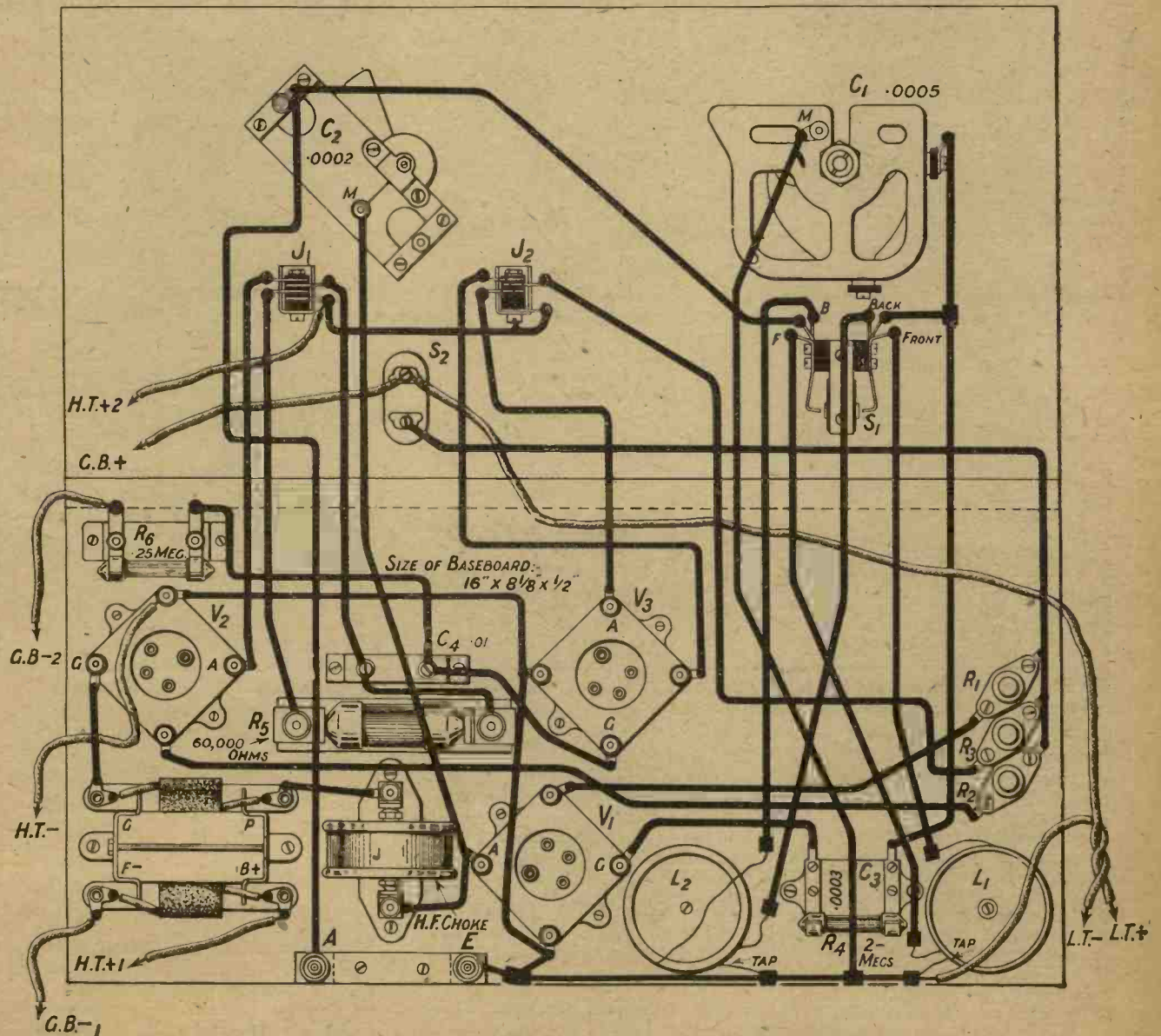

Fig. 4.—The various leads which terminate in arrowheads in this wiring diagram are the connections to the batteries.

The "Davlow Three"—continued

choke coil will be found of distinct service. The value of this choke has some effect upon the smoothness of the oscillation, and Messrs. Bowyer-Lowe have accordingly provided a series of interchangeable high-frequency chokes. It is, therefore, quite interesting to try the effect of interchanging the various values of chokes and noting the effect on the reaction control. For normal purposes a value

Valves to Use

The set may be operated with a variety of valves. The first valve should be chosen partly with regard to the rectifying action, i.e., a valve which is a good detector is desirable, and partly with a view to obtaining smooth reaction control. In the 6-volt class the DFA4, DE5B or DE3HF are available, or even the low-impedance

a low-frequency or power valve. For normal working, however, where two valves are used only for telephone searching, the high-impedance valve is quite satisfactory.

Suitable combinations are as below:—

6-volt: DE5B, DE5B, DE5.
DFA4, DFA4, DFA1.
4-volt: DE3B, DE3B, DE3.
B5, B5, B5.

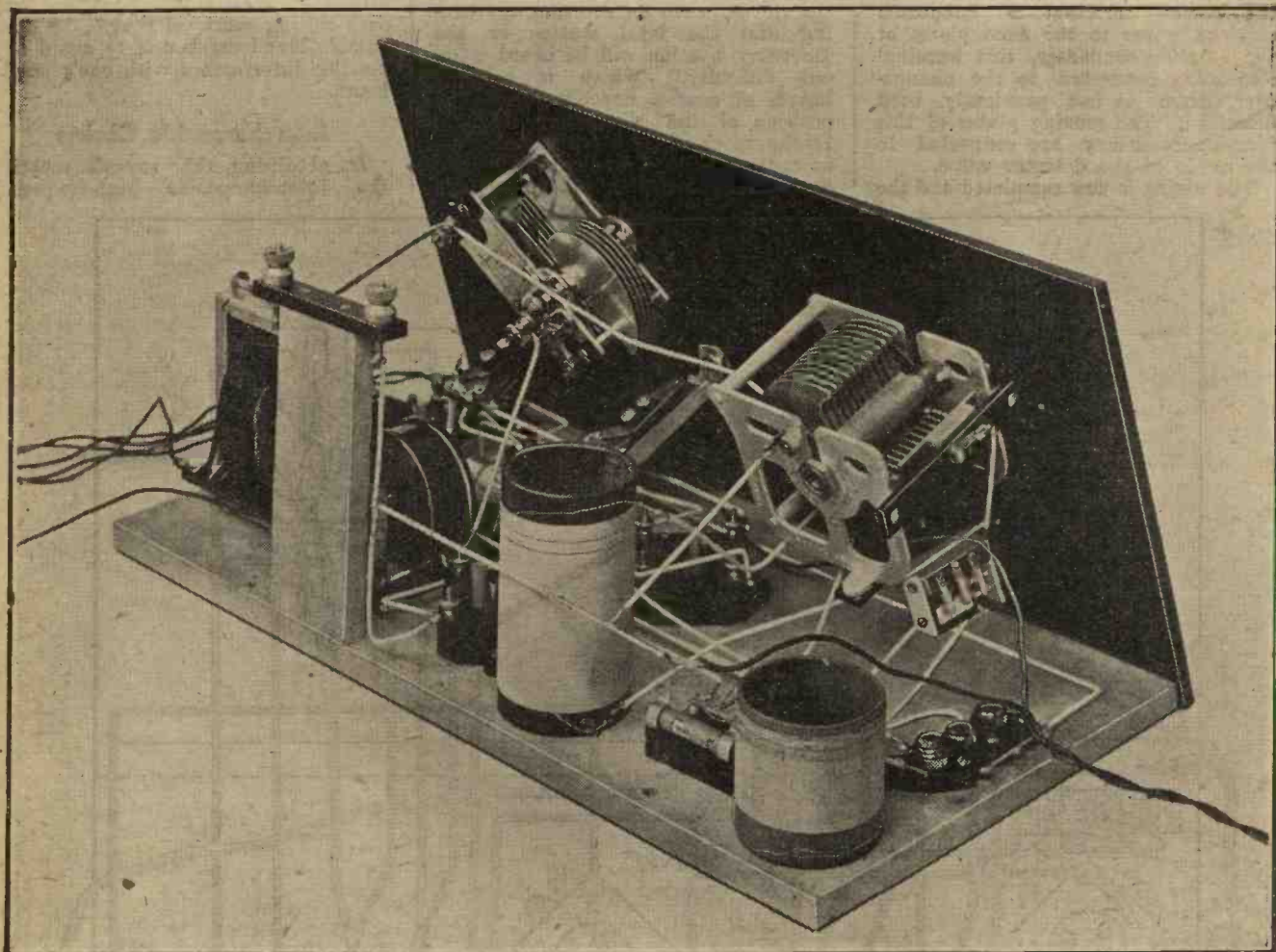

There are no battery terminals on this set. The connections are made with flexible leads soldered directly to appropriate points in the receiver.

of 20 millihenries will be found to be suitable.

The receiver has been tested twelve miles north of London and gave good loud-speaker reception on both London and Daventry on two valves only. Excellent quality and considerable volume were obtained by plugging in to the left jack. Birmingham, Newcastle, Stoke-on-Trent, Nottingham, and several German relay stations could be obtained quite easily in many cases on the loud-speaker, using the three valves; while on the Daventry range Hilversum and Koenigswusterhausen were easily obtainable.

valves of similar rating, such as DFA1, DE5, etc. Corresponding types of two-volt and four-volt valves may be employed if desired.

The second valve should be a high-impedance valve for normal working, in order to get the best from the resistance coupling arrangement, while the last valve should, of course, be a power valve of a suitable type.

When only two valves are employed, a certain efficiency has, of course, to be sacrificed, because the high-impedance valve is not suitable as a last-stage valve. If the set is used for any length of time with only two valves, therefore, the second valve should be

2-volt: DE2HF, DE2HF, DE2LF
or DE6.
SP18, SP18, SP18.

Green spot. Blue spot. Red spot.
Many other combinations will suggest themselves.

High-Tension Voltages

From 40 to 60 volts should be used on the detector, but this depends very largely on the reaction control, and a suitable value should be found at which the set oscillates smoothly. The L.F. and power stages require anything up to the maximum permitted by the makers.

A HELPFUL SUGGESTION.



IT'S VERY NICE TO LISTEN TO THE NIGHTINGALE—BUT HE SEEMS TO WANT A LOT OF COAXING BEFORE HE'LL CONDESCEND TO BROADCAST—AND USUALLY THOSE LISTENERS WHO WANT TO HEAR HIM HAVE TO SIT UP VERY LATE

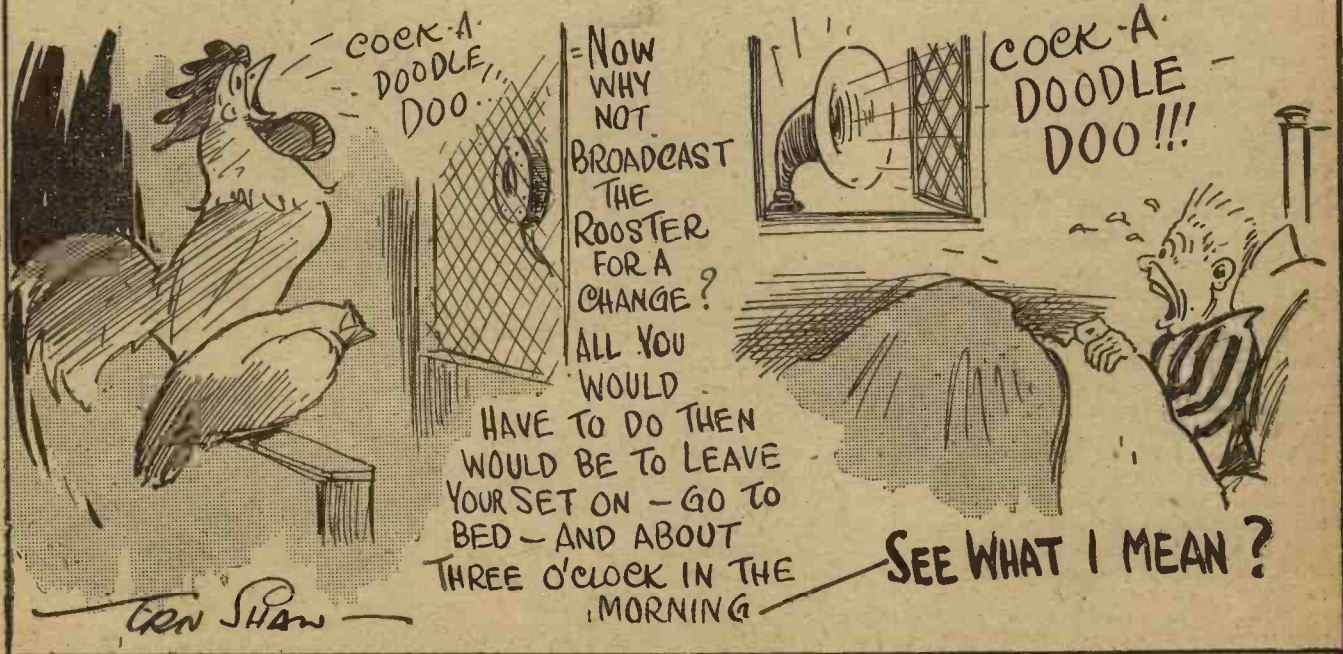

MAKING THE BEST USE OF YOUR ENVIRONMENT

By A. V. D. HORT, B.A.

There is room for ingenuity in designing the best form of aerial system under conditions which fall far short of the ideal. In this article a number of practical suggestions are made for arranging an efficient aerial system under difficulties, and the advantages of making efficiency the first consideration are pointed out.

THE range of a broadcasting receiver—that is to say, its capabilities measured in terms of distance—is probably gauged by most people from the number of valves in it and the arrangement of these valves, with possibly some consideration of the type or style of aerial on which the receiver is used or to be used. This is correct enough up to a point, but in fact the immediate surroundings of the receiver and the aerial will in a great many cases, particularly in town areas, play a quite considerable part in the performance of the receiver.

Special Circumstances

There are certain parts of this country which are well known as "blind spots" from the point of view of broadcast reception. In such places far more sensitive and powerful receiving equipment is required for good reception than the distance and power of the local broadcasting station would seem to warrant. These blind spots, however, are in the nature of special freaks, and a discussion of them is outside the scope of the present article. It is proposed here to deal rather with the types of surroundings which are more commonly incidental to broadcast reception, and to make some suggestions for surmounting the difficulties which are sometimes encountered.

A Dream Seldom Realised

The dream of the enthusiast in wireless reception of any kind may perhaps be crystallised into the vision of a full-sized aerial supported by isolated masts at both ends, on the top of a hill clear of trees, with no other hills in the immediate vicinity dominating the one selected. For the great majority of us, however, this sort of dream has no chance of being realised in fact.

The aerial is more commonly a terribly curtailed wire, low down and shut in by buildings on all sides, with a lead-in which wanders round the walls of several rooms before finally reaching the aerial terminal of the receiver. It is necessary to adjust the aerial to suit individual local condi-

tions, and the results of this adjustment are often somewhat curious in appearance, as everybody knows. It is worth while, however, always to have in mind the ideal arrangement, and to make the actual aerial come as nearly as may be to this.

Summer's Advantage

One great advantage of erecting an aerial during the summer months is that due attention can be paid to the

factory while the tree is bare, but when the spring comes along there may be a puzzling decrease in signal strength, which is not altogether accounted for by the incidence of the normal "summer conditions."

A Tree Mast

A tree in full leaf may exert a very considerable screening effect on an aerial, particularly if the latter ends in the tree. If, therefore, a tree is



Here we see City workers, during their lunch hour, making full use of a congenial environment and listening to wireless orchestral music.

matter of "natural" screening, a point which during the winter can very easily be overlooked. If an aerial is put up in the winter, when the leaves are off the trees, there is a natural temptation, if this support is available, to attach one end of it to a convenient tree. The aerial wire is perhaps fastened to a point about one-half or three-quarters of the way up the tree. This proves quite satis-

to be used as one support for the aerial, the wire should preferably be slung out from the tree on a long "tail" of rope, in order to minimise this screening effect. Of course, if it is possible, the aerial may with advantage be attached to the top of the tree, so that it is not screened by the great mass of the foliage.

Failing this, and if the tree is not very tall, an excellent aerial can often

Making the Best Use of Your Environment—continued

be put up by fixing a pole in the tree, lashing it to the trunk with the top of it protruding several feet above the top of the tree. By this means one is enabled to take full advantage of the tree as a mast, without much of the attendant disadvantages of its screening effect.

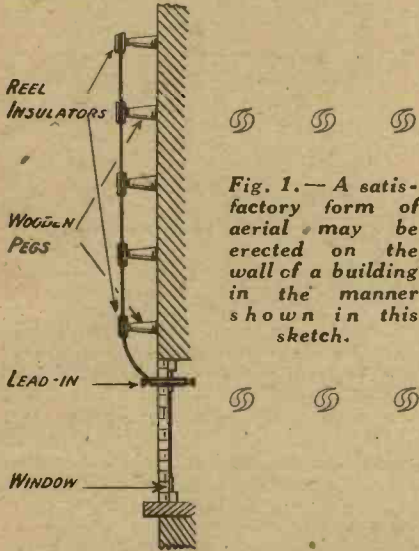

Fig. 1.— A satisfactory form of aerial may be erected on the wall of a building in the manner shown in this sketch.

Buildings with Steel Frameworks

The tendency in modern architecture in the big towns and cities is to use a steel framework for blocks of flats and similar buildings. Anyone who happens to live in one of these steel-framed buildings will know of the screening effect which they exert on any receiver which employs an indoor aerial or a frame. For instance, a superheterodyne receiver using a frame aerial in a steel-framed building at a distance of not more than two miles in a straight line from the aerial of the Londoner has been found to be only just able to bring in signals at faint telephone strength.

This experiment was tried with the receiver and frame situated somewhere near the centre of the building. It was curious and somewhat amusing to note that when the whole apparatus was moved near to one of the windows, which also had a steel frame round the panes, opening the window wide produced an appreciable increase in signal strength!

An Outdoor Aerial Necessary

The effect of hanging a length of wire out of the window to act as an aerial was to make the signals very comfortably audible on the loud-speaker. From this it may be gathered that in buildings which are constructed with a steel frame, one cannot expect to do anything much in the way of distant reception with an indoor aerial or with a frame even with the most sensitive of receivers. An outdoor aerial of some sort is prac-

tically essential, however short and apparently inefficient it actually has to be in practice.

Experiments Essential

This screening effect is not, in the experience of the writer, confined only to steel-framed buildings. It may be found to exist in buildings which are not of this type at all, but which for some reason give rise to the same symptoms in reception. The existence or otherwise of such conditions can, of course, only be discovered by actual experiment with a receiver on various types of aerial. If signals appear to be abnormally weak at a short distance from a broadcasting station and it is known that the receiver itself is not at fault, it is always worth while to try the effect of a wire placed temporarily outside the building. This wire should be slung as far from the walls as possible for the purpose of the tests, although it may be necessary to arrange it in a rather less efficient position when it comes to the final fixing.

Overcoming the Difficulty

One method of erecting an outside aerial in circumstances such as those which have been described is shown in Fig. 1. This method is particularly suitable for use by the man who lives in a tall block of flats, the receiver, if possible, being situated at the lowest point of the aerial and the latter

this case to use insulated wire for the aerial, to minimise leakages owing to its swinging against the wall.

The better method is shown in the sketch, the wire, which need not in this case be itself covered with insulation, being supported every few feet by insulators on the ends of pegs fastened in the wall. This type of aerial, while being more troublesome and elaborate to fix than the wire between the window-sills, will prove in practice very satisfactory, because of its immunity from the possibility of swinging.

Another Possibility

When any clear space, such as a backyard or garden, is available, the fullest possible use should be made of it. Assuming that either method of erection is possible to the tenant of the house, he will be wise to make practical trial of reception both with an aerial arranged from the roof of the house down to the remote end of the space available and with a shorter aerial slung up on the roof itself, either between the chimneys or on short masts. If screening is at all noticeable in the locality, the latter method may prove the better of the two, the fact that the top part, at any rate, of the aerial is not down below the level of the roofs or screened by trees compensating for its comparatively short length.



Recently, at Bristol, 8,500 children gave a demonstration of modern methods of physical culture. Marconi-phone loud-speakers enabled the voice of Sir Ernest Cook, B.Sc., J.P., to be heard quite clearly by the huge audience.

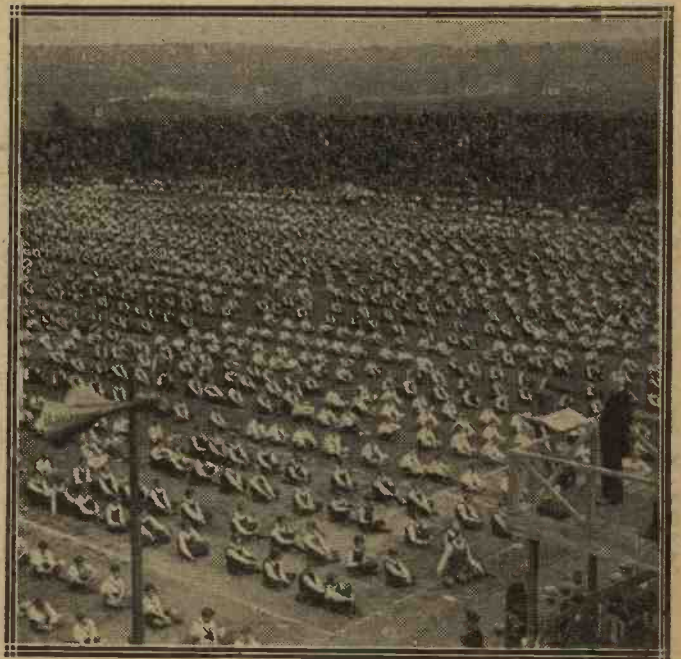
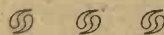

running up the wall of an area, for example. If the wire can be stretched tightly between the projecting window-sills of windows vertically one above the other, this arrangement may prove satisfactory. It will be preferable in

Locating the Receiver

One point which should be borne in mind always when erecting an aerial is that the receiver should, if possible, be at the lowest point of the aerial.

Making the Best Use of Your Environment—continued

It is not denied that results can be obtained without the observance of this rule. The first aerial ever put up by the writer was, in fact, below the receiver for its whole length! It started from the receiver, a crystal set, at a window about 40 ft. above the ground and went steeply down to a small pole about 100 ft. away. Morse signals and amateur telephony, the only signals available in those days, were heard with this arrangement; but it could not be regarded as efficient, especially as the earth lead was 40 ft. long, a wire down the side of the house to a buried mass of metal.

An Analogy

In the vicinity of a broadcasting station this sort of aerial may be enough for local reception, but it will usually have to be regarded as something of a "passenger," not really doing its full part to help the receiver to perform its work. In the same way an aerial system which is so badly arranged that the losses in it are very high really makes unnecessary demands on the skill of the operator.

It is well known that a single-valve receiver with reaction, for example, can reach out to a large number of stations under good conditions and with an efficient aerial system. If, on the other hand, the aerial system is a "high-loss" one, greater demands will be made both on the reaction required and also on the operator's skill in tuning. To couple a thoroughly bad aerial to a good receiver is akin to fitting solid tyres to a car designed for comfortable travelling.

Not Good Practice

The position which the receiver itself is to occupy in the house must

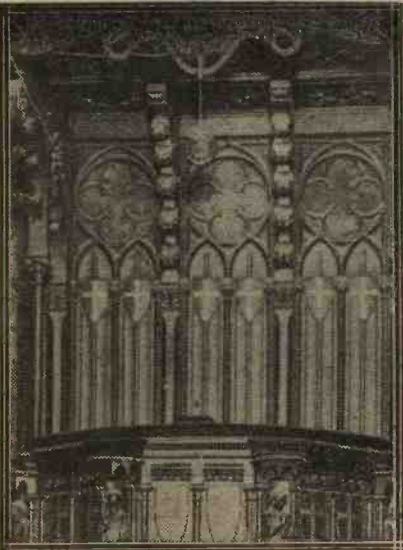

This photograph of the pulpit of the Notre Dame, Paris, shows the microphone suspended from the canopy.

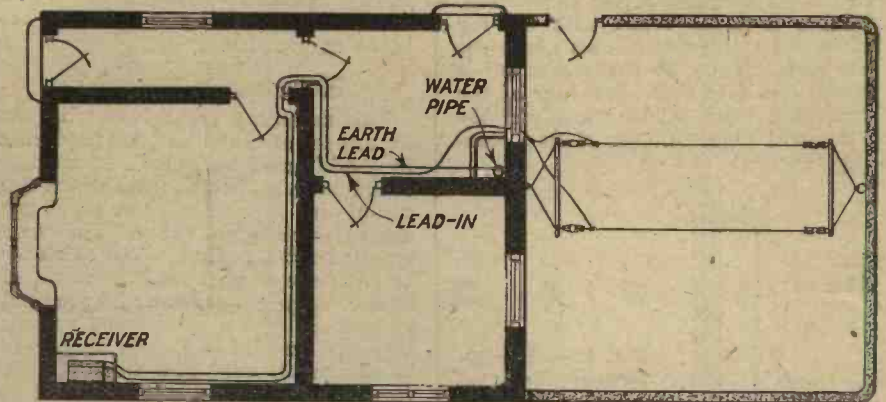

Fig. 2.—The arrangement of the aerial and earth leads shown in this sketch cannot be regarded as efficient, though the positions of the rooms may render it almost unavoidable.

necessarily have some effect on the design of the aerial system. It is undesirable to have a lead-in which has to pass through several rooms before reaching the receiver, but at the same time it is often difficult to arrange matters otherwise. Fig. 2 shows how the receiver is sometimes placed relative to the aerial in a small house.

The living room is at the front of the house, while it is most convenient to erect the aerial at the back. The water pipes, which form a suitable earthing point, are also at the back of the house. The result is that the aerial and earth leads start somewhere fairly close together and run together through the house to the receiver.

Sacrificing Comfort to Efficiency

Now the best arrangement here, from the point of view of efficiency, would be to put the receiver close to the place where the lead-in enters the house and so near to the earthing point. Leads for the loud-speaker could then be run into the front room without loss of efficiency, and remote control could be installed also if desired.

This would be satisfactory for the reception of the local programme, but if the tuning-in of distant stations was to be carried out, it would mean that the operator would be exiled to the back room; comfort would have to be sacrificed to efficiency. In a case like this, if the operator, as is to be expected, did not approve of excursions to the back of the house every time that he wished to listen to stations in other countries, it would be worth trying various experiments.

Two Useful Suggestions

Assuming that the earth lead was to be attached to the water pipes at the back, whatever aerial was used, the experiment might be tried of separating the aerial from the earth as far as possible by leading it in at

a window on the floor above and bringing it down the stairs into the front room. This might offer chances of keeping the aerial further from the walls than in the other case. Again, provided that circumstances permitted, an aerial might be erected on the roof of the house, and the lead-in brought down over the front of the house as far out from the wall as possible, and so in through the window of the front room.

A Point to Notice

When an excessively long earth lead is necessitated by the position of the receiver, it will usually be worth while to try the effect of a counterpoise earth. This may consist of a length of insulated wire laid round the skirting of the room, and possibly extending out into a passage or another room.

With some valve receivers, notably those employing the simpler types of straight circuits, this change will usually be found to affect considerably the operation of the receiver. The reaction control, especially if reaction is applied to the aerial circuit, may require much "lighter" handling. It should not take long to become accustomed to the new conditions, and this point is only mentioned because some operators might discard the counterpoise without further experiment on finding this alteration in the behaviour of the receiver.

An Indoor Aerial

When it is quite out of the question to erect an outdoor aerial, it remains to make the best use of the space available indoors. If a frame aerial is not adequate for the receiver to be used, it will usually be possible to try two or three different arrangements of the indoor wire. The first and most obvious of these will be simply to hang a wire across or round the room in which the receiver is situated,

(Continued on page 958.)

AUSTRALIA ON TWO VALVES

By PERCY W. HARRIS, M.I.R.E.

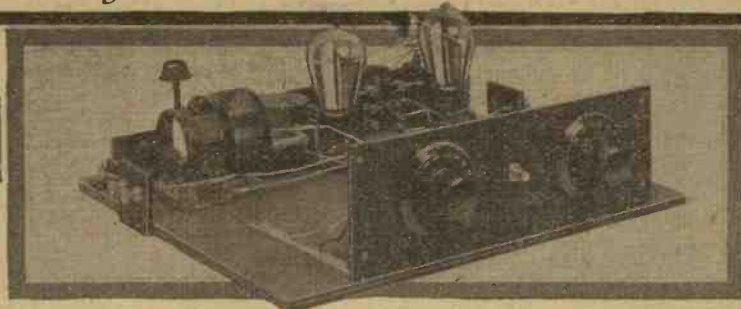

Do you know that there are hosts of interesting transmissions on the short-wave band waiting for you to explore them? The receiver described in this article will enable you to listen to them.

EVERY experimenter should have a short-wave receiver. With our present knowledge it is so easy to make and so deadly certain in its results. With no other kind of receiver is it possible to guarantee the reception of American broadcasting on three or four nights of every week, and in the winter months sometimes every night for several weeks at a time. With no other kind of receiver is it possible to hear amateur signals from so far away as Australia and New Zealand, while both in daylight and after dark our Transatlantic cousins can be heard every night without exception. "Only with skilful handling!" you may say. Not at all! In the words of the advertisement, "A child can use it."

Simplicity Itself

In this article I am going to describe to you a very simple short-wave receiver, that can be duplicated by any intelligent reader in an evening, and which, if he has not used a short-wave receiver before, will astound him with the results it will give. As to its sensitivity and general efficiency, I have nothing in my collection of apparatus to beat it, and I use it exclusively for all my short-wave reception at the present time.

It consists, as for that matter do the majority of short-wave receivers used by experienced amateurs, of a two-valve arrangement, the first valve being used as a detector, and the second a note magnifier. The wavelength range is from about 12½ metres to approximately 200 metres. It is quite unnecessary to wind any coils yourself, as these are purchased in a complete set, the coils for various ranges being immediately interchangeable. There are but two tuning controls, both condensers, that on the left tuning the grid circuit, and that on the right controlling the reaction.

The Aerial Circuit

The aerial is loosely coupled by the method often called "semi-aperiodic

coupling," the same aerial coil serving for all the grid coils, from the smallest to the largest. In series with the aerial condenser is placed a clip mounting, so that different values of fixed condensers may be tried as desired. In this method of coupling it is advisable that the aerial should not be exactly tuned to the wavelength you wish to receive, and on those adjustments where "dead spots" occur, the insertion of a small fixed condenser—say .0001—will de-tune the aerial and so make good reception possible on this wavelength.

The construction is exceedingly simple. A baseboard is used, measur-

The Condensers

Here is the complete list of components required. I may say that for coupling the detector to the note-magnifying valve I have used the Watmel Audio-frequency choke unit, which contains the choke coil, coupling condenser and grid leak. I have found this unit very useful and efficient for telephonic reception, as it has a particularly silent background and gives quite good amplification. It can, if desired, be replaced by any good make of low-frequency transformer, while such items as valve sockets, variable condensers, and so forth can be

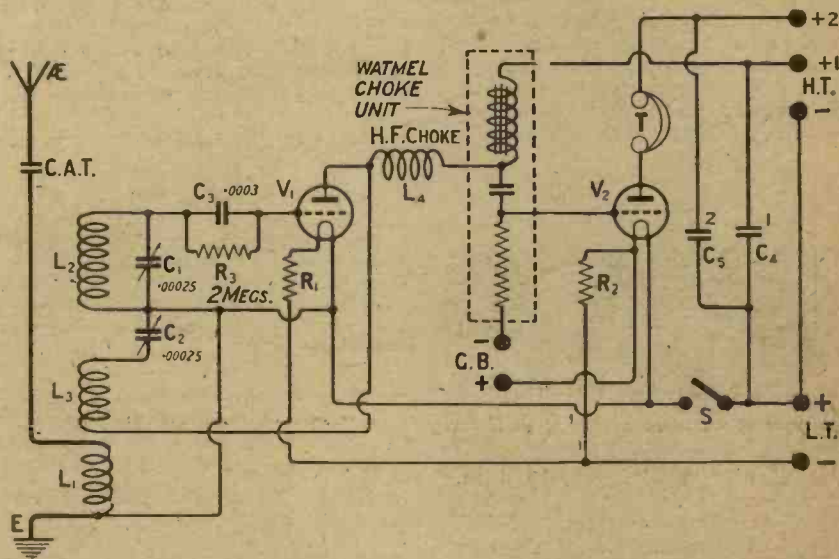

Fig. 1.—It will be observed that choke coupling is utilised for the note-magnifier.

ing 16 in. by 14 in. by ¼ in. or more in thickness, this carrying an ebonite strip screwed to the front with a couple of brackets to support it. With the exception of the variable condensers and an "on and off" switch, the various parts are simply screwed to the baseboard in the positions given, and wired up in the conventional manner.

of any good make previously recommended in this journal. As to the variable condensers, care should be taken to get good quality instruments, and I do not recommend the use of variable condensers with single plate verniers operated by a spindle running through the central shaft. Such condensers may serve excellently in certain circumstances, but in short-wave work

Try Short Wave Reception Yourself

I have not found them satisfactory, and, indeed, some condensers of this type are not satisfactory on any wavelength. The condensers I have used in this set—the Ormond—have a vernier adjustment of a form which has proved particularly useful and efficient on short wavelengths, being perfectly free from backlash and smooth in operation. Tuning is too sharp for condensers without a good vernier adjustment.

Components Used

One baseboard 16 in. by 14 in. by $\frac{1}{4}$ in. or $\frac{3}{8}$ in.

One gridleak, 2 megohms. (Dubilier Condenser Co. (1925), Ltd.)

One terminal strip carrying L.T. —, L.T. +, H.T. —, H.T. +1, H.T. +2, grid bias +, grid bias —. ("Magnum"—Burne-Jones & Co., Ltd.)

Two small strips of ebonite of any convenient size (approximately 2 in. by 2 in.), with aerial and earth terminals and telephone terminals, as shown.

One base for clip-in condensers. (L. McMichael, Ltd.)

Clip-in condensers, values of, say, .0001 or .0003 (L. McMichael, Ltd.). In most cases a single condenser of

controlling filament current. Four ohms each is recommended. ("Magnum"—Burne-Jones & Co., Ltd.)

Constructional Work

Begin by drilling the ebonite panel for the securing screws to hold the brackets; and the three holes to take the two condensers and on and off switch respectively. The three holes for carrying these last can be made with a $\frac{3}{8}$ -in. drill. Secure the brackets to the ebonite panel by means of four 6B.A. metal screws and nuts. Next secure the on-and-off switch and the two variable condensers in place (this is but the work of a few moments), and place the front panel with its brackets on the baseboard in the positions shown, securing it with wood screws to the base itself. Now place the other components in position and attach the large and two small terminal strips; wiring up can then be carried out rapidly and neatly, according to the diagram of Fig. 3. A full-sized blue print will help you to measure off and bend the wires accurately, and this, as you know, can be obtained under the WIRELESS CONSTRUCTOR free blue print scheme by sending the coupon on page 960.

Valves to Use

The set is not at all critical in regard to valves, but I have found the best results obtainable with a high-impedance valve, of the type designed for resistance-capacity coupling, as the detector, and what is commonly called a small power valve for the note magnifier. For the detector valves, a D.F.A.4 (Mullard), a D.E.5b (Marconi and Osram), or a C.T.25b (Cleartron) will, any of them, give first-class results. For the second, a D.F.A.1, D.E.5 or C.T.25 of the three makers just named will give equally good results. For high-tension 20 or 30 volts will generally prove sufficient for the detector valve (H.T. + 1), and for the note magnifier 60 or 70 volts will be sufficient (H.T. + 2). For the benefit of readers who are just starting experimental work in making sets, it should be said that the H.T. negative socket of the battery is connected to H.T. negative terminal, by means of a lead and a wander plug. H.T. + 1 is connected by a lead to a wander plug which can be plugged in at suitable tapping between 20 and 30 volts (you will find this best by experiment), while H.T. + 2 is joined by a similar lead to a wander plug in the same battery at, say, 72 volts. A grid bias battery tapped at each coil should be used. 3 to 4½ volts will give satisfactory results.

Operation

It is best to practise on the largest of the four coils if you are not used to handling a short-wave receiver. The

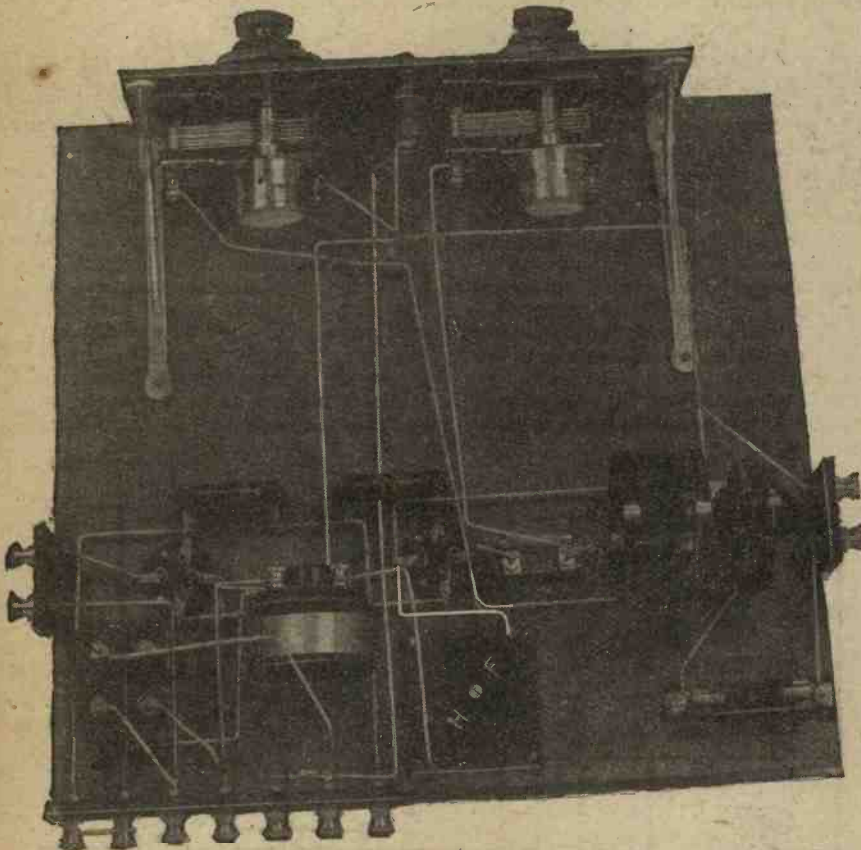

The condensers are kept well away from the rest of the components.

One ebonite panel 12 in. by 4 in. by $\frac{1}{4}$ in. or $\frac{3}{8}$ in.

Two variable condensers .00025. (Ormond Engineering Co., Ltd.—slow motion.)

One on-and-off switch. (Igranic Electric Co., Ltd.)

One set of Bremer-Tully short-wave coils and coupler. (These are obtainable in England through the Rothermel Radio Corporation of Great Britain, Ltd.)

Two valve sockets. Board mounting type. (Peto-Scott Co., Ltd.)

One fixed condenser, with clips for gridleak, .0003. (Telegraph Condenser Co., Ltd.)

.0001 will be sufficient, but it is convenient to have one or two to experiment with.

One radio-frequency choke. (Success—Beard & Fitch, Ltd.)

One audio-frequency choke unit. (Watmel Wireless Co.)

Two fixed condensers, Mansbridge type, of any convenient size over $\frac{1}{2}$ a microfarad. One microfarad each is a good value. (Telegraph Condenser Co., Ltd.)

Two brackets for front ebonite panel. ("Magnum"—Burne-Jones & Co., Ltd.)

Two bases for fixed resistances, and suitable plug-in fixed resistances for

A New Field to Explore!

largest of these coils tunes from approximately 100 to 200 metres, and between these ranges you will hear a large number of Morse stations. Plug in the largest coil, set the coupling coil at about 45 degrees to the plug-in coil, plug the two 4-ohm resistances in the two sockets shown, set the right-hand or reaction condenser at zero and the left-hand condenser at zero also; connect up the

coil as near to a right angle as possible without weakening the signals unduly. This means loosening the coupling. If you are able to read Morse you will be able to identify the call-signs, but if you do not understand the code you will probably prefer to search until you hear amateur telephony. When hearing telephony the set should be adjusted just below the oscillating point, or you will get

tened for two hours without a break to the programme from KDKA on such a two-valve receiver, and did not miss a single song, word, or talk during that time. Even after seventeen years of amateur wireless reception I could not help being thrilled by the fascination of listening on such a simple set to perfectly clear telephony from over 3,000 miles away.

On the second coil which tunes from about 25 to 50 metres you will frequently hear telephony from the American Broadcasting Station WGY at Schenectady, the New York Station. This station broadcasts on about 38 or 40 metres, and comes in extremely well in this country. On the shorter wavelength coils you will sometimes find that it is not possible to make the set oscillate on certain readings. When you find such a point either pull out the particular clip-in condenser you are using at the moment or else short-circuit it with a piece of wire. Either method will change the wavelength of the aerial circuit, and will enable you to receive on that portion of the wavelength band.

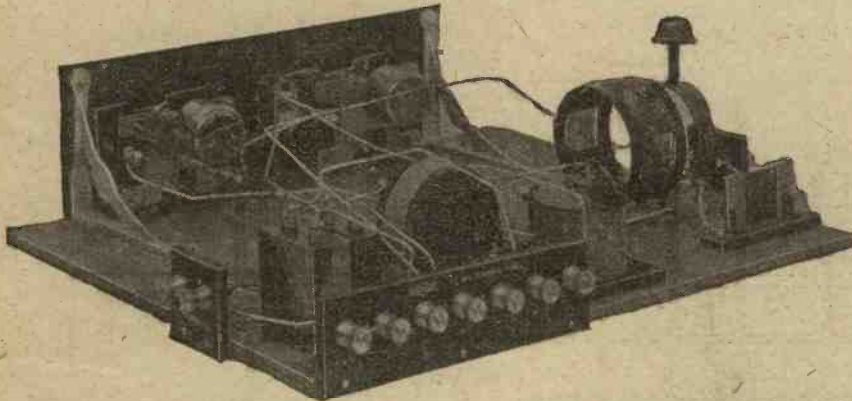

Only a few components are required.

batteries as indicated and pull out the on-and-off switch. Both valves should now light. If all is well, do not trouble to connect aerial and earth, but with the 'phones on your head, turn the reaction condenser slowly from zero onwards until you hear a rushing noise which indicates that the set is oscillating. Turn the left-hand tuning condenser to say 10 degrees and try the reaction again, repeating the process every 10 degrees all the way round the scale from zero to the highest reading. If all is well, the set should pass smoothly into oscillation at any reading of the left-hand condenser when the right-hand condenser is turned slowly from a lower to a higher reading.

Preliminary Searching

Having become accustomed to this reaction control, connect the aerial and earth, turn the left-hand tuning condenser backwards and forwards slowly, keeping the set just below the oscillating point. You will probably hear sundry Morse signals from amateur transmitting stations, some being musical notes and others rough untuned notes. For reception of continuous wave signals, it will be necessary to take the reaction condenser just pass the oscillating point, when you will be able to settle on a convenient musical note for the particular signal by adjustment of the tuning condenser. The best continuous wave signals are heard when the set is only just oscillating, and in such circumstances you should turn the coupling

such distortion that the speech and music will be unrecognisable.

American Telephony

Having satisfied yourself that you can control and listen to signals on the biggest of the four coils, take the third coil which tunes approximately from 50 to 100 metres. This is a very interesting coil, and on this you will hear large numbers of amateur signals, both Morse and telephony, and in addition you will be able to hear American broadcasting from the

Amateur Transmitters

Of course, if you are able to read Morse you will be able to find and identify a whole host of stations. The American amateurs generally work on one of the following bands: 18 to 22 metres, 37-43 metres, 75-86 metres. In this country 23, 45, 90-100 metres and 150-200 metres are widely used by amateurs, and similar wavelengths are used by most of the Continental experimenters.

As the reception of American and Continental amateurs is such an easy matter, and there are so many hun-

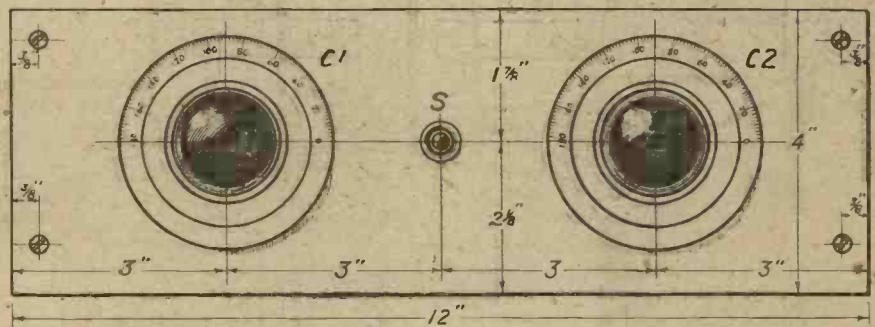

Fig. 2.—Only two controls are required, one for tuning and one for reaction. A blueprint of this panel (No. C1055 (a)) may be obtained under our free blueprint service. See page 960.

KDKA Station on 63 metres. This station is generally audible from about half-past eleven at night onwards, and frequently is so loud, when properly tuned in, that you can hear it with the 'phone several inches from your head. On one occasion I sat and lis-

tered to be heard on any good night, it would be waste of space to publish a list of the results on this receiver. It should be pointed out, however, that KDKA and WGY, both American Broadcasting Stations, have been received on dozens of occasions within

Australia on Two Valves—continued

the last two or three months, and in fact on only one night have I failed to hear KDKA when I listened for it with this set. In order to compare the results obtained at my home with those obtained elsewhere I lent the set to Mr. L. H. Thomas (6QB), and some of his results are given below. Notice that he received no less than six or seven Australian amateurs'

transmissions before breakfast one morning, in broad daylight (eight o'clock in the morning here corresponds with six o'clock in the evening in Eastern Australia).

An Indoor Aerial

As I have indicated above, even if you have no knowledge whatever of the Morse code, the set is worth build-

ing for the reception of American broadcast telephony. If conditions are good you will even be able to hear KDKA and WGY on a small indoor aerial.

On one occasion I heard KDKA with a two-valve short wave receiver, not so good as that being described, on but ten feet of wire, strung across my laboratory.

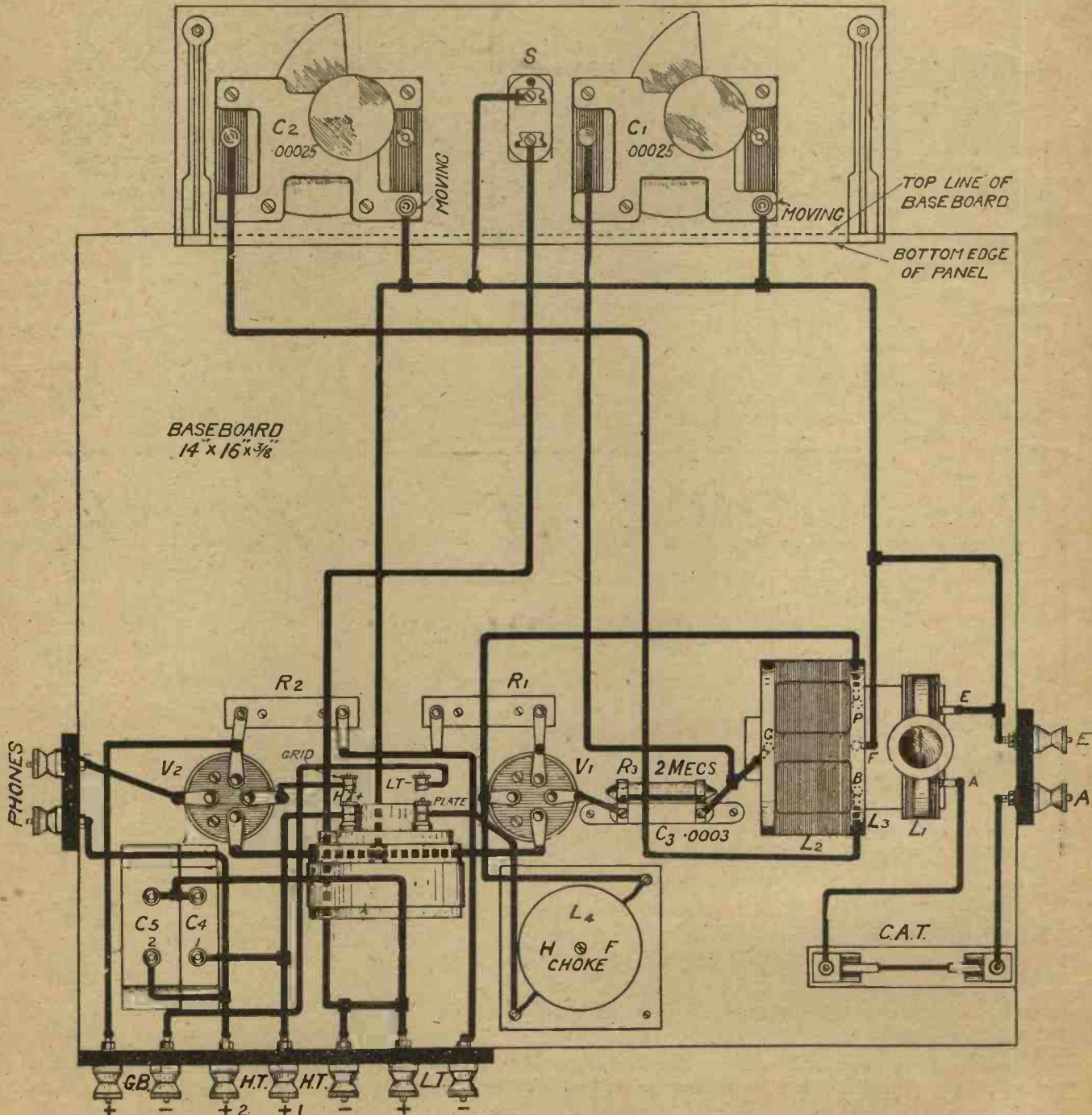

Fig. 3.—This diagram shows the wiring clearly. Blueprint No. C1055 (b) is available for those who prefer it.

See if You can Get it!

As soon as you get American broadcasting on this receiver, please send a postcard giving us your results; if possible, give the name of the items being broadcast at the time which you

which parts of England are best for short-wave work, and whether the signals are received equally well in several parts of England, at the same time.

25-45 metres: Various Brazilian stations and numerous Europeans, between 2130 and 2330 GMT. Between 0630 and 0830 various Australian stations were heard, one of them, A-3BD,

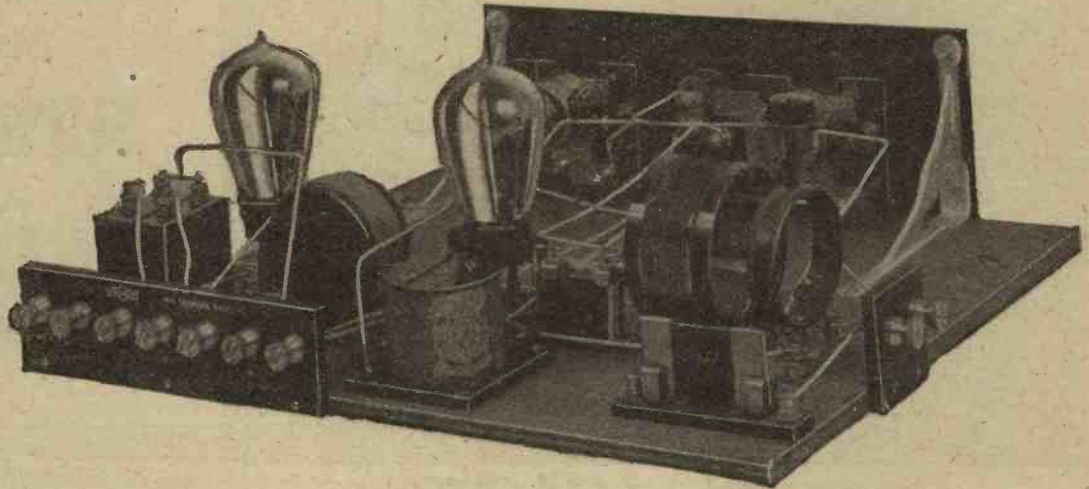

High impedance valves of the quarter ampere type are used in this receiver.

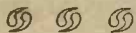

heard them, so that we can send the results to the Broadcasting Stations in America. At the same time mention the kind of aerial you were using, and the weather, as well as the date. In this way we might be able to find

Stations Heard

15-25 metres: Several commercial stations were heard on this wave-band, including LPZ (Buenos Aires) and some of the Nauen stations.

being received almost at loud-speaker strength.

45-200 metres: Chiefly British amateur stations on telephony, but several Europeans using Morse between 90 and 130 metres.

IMPORTANT NOTICE!

COPYRIGHT

NOTICE is hereby given that articles, test reports, &c., contained in this Journal, are copyright and may not be reproduced in whole, or in part, without written permission from the Publishers.

In view of the important technical developments forthcoming from Elstree and the evolution of new designs and circuits, it is considered reasonable to indicate to all concerned (including readers of this Journal who may write for other papers) that RADIO PRESS, LIMITED, will take the necessary legal action where unfair advantage is taken of their Publications.

Development work is very costly and is conducted by the Publishers for their own readers. The reproduction in other Publications of the material and information gained is, apart from other considerations, a gross act of unfairness.

In the past RADIO PRESS, LIMITED, have by legal action in the High Court and by other means protected their Publications, and it is their intention to continue to do so.

It is also desired to point out that the word "Elstree" as applied to radio apparatus and the names of most of the receivers described in Radio Press papers are trade marks.

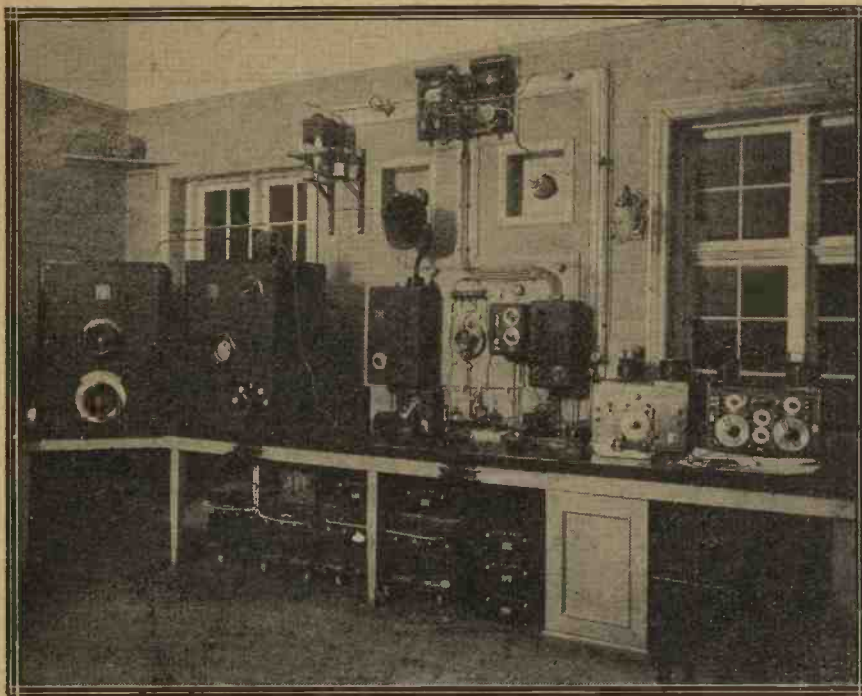

A view of the transmitting room at the Ryvang station.

MID-WINTER, one would say, is hardly the time to choose for a trip to the Northern countries of Europe, but it must be remembered that their climate is far more temperate than that of other countries in similar latitudes, such as Canada, owing to the modifying influence of the Gulf Stream. The winter cold is, of course, severe, but it is a dry, crisp and exhilarating one, and I did not regret my undertaking to pay a flying Christmas visit to Scandinavia, in order to investigate at first hand the conditions of broadcasting among our friendly neighbours across the North Sea.

Speed with Comfort

The journey I am about to describe I have often referred to as an interesting method of spending six nights and five days to go from one platform of Liverpool Street Station to the other. In view of the short time at my disposal such strenuous travelling was necessary in order to visit the five broadcasting stations situated on my itinerary. One cannot help marvelling at the wonderful network of transportation which is daily at the disposal of the hurried traveller. Although speed is the first consideration in such arrangements, the comfort of the traveller is also studied to a remarkable degree, and it was these two factors which made it possible for me to travel 4,000 miles in those five days, passing through five countries and traversing two seas.

I wished during the journey to devote my full attention to the position of broadcasting in these countries, and I realised that in addition to visiting the broadcasting stations, their

studios and transmitting gear, exchanging views with the station directors and radio journalists, and investigating the position of wireless trade and legislation in the countries traversed, it was necessary to listen under the best possible conditions to the actual transmissions from all main and relay stations.

Investigating Broadcast Activities

In order to do this a portable set was indispensable, and I accordingly travelled, as I usually do, accompanied by my seven-valve super-sonic heterodyne with frame aerial, all enclosed when not in use in portable leather cases. It was thus simple, whenever I found myself with an idle moment to spare, be it in hotel, car, train or boat, to tune in any particular station in the vicinity, and under these most favourable conditions to investigate and become familiar with the methods and activities of the broadcasting world through the ether channel.

Although Denmark, Norway and Sweden are adjacent countries, and are in the minds of many people grouped together as existing under similar conditions, as, indeed, they do from many aspects, they are far from being in the same position with regard to broadcasting. For instance, while the art has reached a high standard of efficiency in Sweden, it is developing very slowly in Denmark.

Conditions in Denmark

During a most enjoyable and illuminating chat with Mr. Axel Petersen, with whom I breakfasted soon after my arrival in Copenhagen, I gained some idea of the confusion that existed in the "wireless world" of

IN SCANDINAVIA WITH A SUPERHET

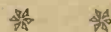

By Capt. L. F. PLUGGE

Denmark. Here progress is being retarded by conflicting interests opposing one another in order to gain for themselves the maximum amount of advantage from the new venture before them. Mr. Petersen himself is one of the leading members of the Committee of the Radio Society of Denmark, which is called "Litterforeningen," and he and his society advocate the establishment of a private broadcasting organisation like the British Broadcasting Company to take over the whole transmitting service, as is the arrangement in England. Listeners, he told me, are somewhat dissatisfied with what has already been done under direct Government control.

Political Interests

On the other hand, the various political parties wish to retain every possible hold on such a great national asset as a broadcasting service undoubtedly is, both for propaganda purposes abroad and also as a means of moulding public opinion and taste in the homeland. All this contention of rival interests has probably harmed the broadcasting position in Denmark. Until recently, therefore, Denmark was at the level reached by other countries one or two years back.

This was greatly to be deplored, especially as Denmark made a very promising start in the radio field. Denmark was, for instance, the first country to establish two-way communication for the use of passengers between coasting steamers and the mainland. It is pleasing to note how Denmark has now gone ahead in its broadcasting activities, and is daily becoming in this field a more worthy rival to its sister country of Sweden. Danish listeners owe much to the

In Scandinavia with a Superhet—continued

activities of the Copenhagen Station Director, Mr. Oleseu, who is also the distinguished editor of the wireless journal, *Radio Uge-Revue*.

Copenhagen Programmes

My short visit to Copenhagen proved extremely interesting, as, in addition to enjoying such interesting conversations with wireless amateurs of the country, I was able to visit both the broadcasting stations which are at present working there. York's Passage, as the older of the two is called, is situated in the centre of the town, and has been working since 1924, having previously been erected by Danish amateurs and radio traders, though it was soon taken over by the State. The programmes given from this station are very good, and transmissions leave little to be desired. It is interesting to find that the arrangement of the programmes include regular lessons in English, and that these are given by a Scotsman who has been resident in Copenhagen for some eight years.

I proceeded in the afternoon by car through the snow to Ryvang, where I found another model broadcasting station, the installation and gear in this great military station being perfect in every respect. Ryvang has become a broadcasting station in the ordinary sense of the term only in order to keep the gear in use and to provide training for the soldiers. It broadcasts only outside concerts and relays, but its transmissions are excellent in quality, and can easily be heard without interference from York's Passage owing to the wide difference in wavelength, Ryvang using the long wave of 1,160 metres, while that used by York's Passage is 347.5 metres.

A New Station

Commander - Engineer Thomsen, Commanding Officer of the Ryvang station, kindly received me and gave me much interesting information as to the present position and probable future of broadcasting in Denmark. It is likely that a large high-power station will shortly be erected, probably at Aarhus, which is a central point for the whole country of Denmark.

I was very interested to discover, both when listening in at odd moments while in Copenhagen, and also when on board the boat in which I crossed to Sweden, that Maln , though a Swedish station, is quite the best station to listen to even in Denmark, and I was disappointed not to be able on this occasion, owing to lack of time, to visit it. Arrived in Stockholm, however, I found ample occupation for every minute of my time in exploring the position of broadcasting there, and had many very interesting opportunities of comparing it with the state of things in the country I had just left.

Swedish Efficiency

It is well known, of course, that the Swedish broadcasting service has reached a very high standard of efficiency, and is, in fact, in the opinion of many, second to none in the world, not even our own, of which we are justly proud. My visit to the Stockholm station was rendered doubly interesting by the courtesy of Mr. Nils Holmberg, Director of the station, who is one of the most important figures in the broadcasting world of Sweden, as he is also director of programmes to the whole Swedish service. He told me the absorbing story of the wonderful progress of broadcasting in Sweden

sions. The other half goes to a private company for providing the programmes called "Radiotjanst." This plan has many advantages. The Government is in a position to ensure a highly efficient staff of operators, and the best and most reliable transmitting gear obtainable, while "Radiotjanst," which is naturally composed of men anxious to please the public, ensures excellent programmes and secures frequent novel and interesting outside broadcasts.

The Stockholm station is the only Swedish station situated in the centre of the city, all the others having been erected about three miles away from the town to which they belong in order



Mr. N. Holmberg, the programme director of the "Radiotjanst."

since its inauguration some two years ago, and put me quite *au fait* with the conditions as they are at present.

The Licence Question

Licences in Sweden are levied on every listener, as in this country. Half of the money thus paid goes to the Post Office, which is responsible for the engineering, electrical and general technical side of the transmis-

to enable listeners in the town to tune in distant stations. I noted during my brief visit to the Stockholm station several details of arrangements which give it an individuality of its own. For instance, the beginning of each transmission is indicated, not by a tuning note, as we understand it, but by the playing of certain Swedish folk tunes on a piano, so that Swedish listeners to whom all these national

In Scandinavia with a Superhet—continued

tunes are familiar can immediately recognise their own station. The switching on of a double bell during intervals in the programme is a useful device to prevent a gap in the trans-

mission, and thus facilitate accurate tuning in during intervals.

of transmission between programmes from a main station and those relayed by land line. They are both received with equal purity and strength.

The Swedish nation have always

to hear on several occasions excellent retransmissions from Swedish stations of some of the best items of foreign programmes. These are primarily received at a Government station situated at Kungsbacka, and sent by land line to the other stations. The excellence of this relay provides an added pleasure for the enthusiastic listener. British transmissions in particular are regularly relayed in this manner, and are much appreciated by the Swedish amateur.

Journalism in Sweden

After carrying out my extremely full and varied programme during my one day in Stockholm, having gained many varied impressions and made many interesting discoveries, I departed on the night train for Gothenburg the same evening, arriving in this most important of Swedish provincial cities just as the dawn was breaking over the snowy landscape. The cold dry air was sufficiently invigorating to make breakfast a welcome prospect, doubly so as, while enjoying it, I was able to "talk radio" with the leading wireless journalist of the city, Mr. Arvid Palmgren, the editor of the best technical radio journal of the country, *Radio Amatören*. Mr. Palmgren told me that, although many listeners in Sweden prefer to buy their receiving sets, the proportion of those who prefer to make their own is very large, and the sale of technical periodicals such as his is very considerable.

The Gothenburg Station

The broadcasting station at Gothenburg, which I was able to visit later



A well-known Swedish baritone, Mr. Gunnar Griju. At the piano Mr. V. Broman, musical director of the "Radiotjänst."

mission, and thus facilitate accurate tuning in during intervals.

An Interesting Arrangement

An interesting and highly successful method of increasing the number of relay stations in operation in Sweden might with advantage be followed in other countries also. The citizens of any town who are sufficiently enthusiastic to do so are encouraged to pay for the installation of a relay station. Their responsibility ceases once the station is working—"Radiotjänst" immediately takes over the programmes side of the enterprise, while the Post Office becomes responsible for the technical and engineering section of the new station. The station at the same time never ceases to remain the property of the purchasers, although all further expenses are met by the licence fees levied on listeners.

So successful has this plan proved that to-day Sweden has, in addition to her five main stations, Stockholm, Gothenburg, Malmö, Sundsvall and Boden, some twenty relay stations connected by land line to one of the various main stations.

Excellent Quality

That the proportion of listeners in Sweden works out at about a quarter of the total population of the whole country is a clear proof of the excellence of both programmes and transmission. I discovered that it is often impossible to distinguish by the quality

from earliest times been renowned for enterprise, progress, and a vital interest in the world around them and in countries outside their own. This is exemplified in broadcasting as in other forms of expression of the national life. I was very interested

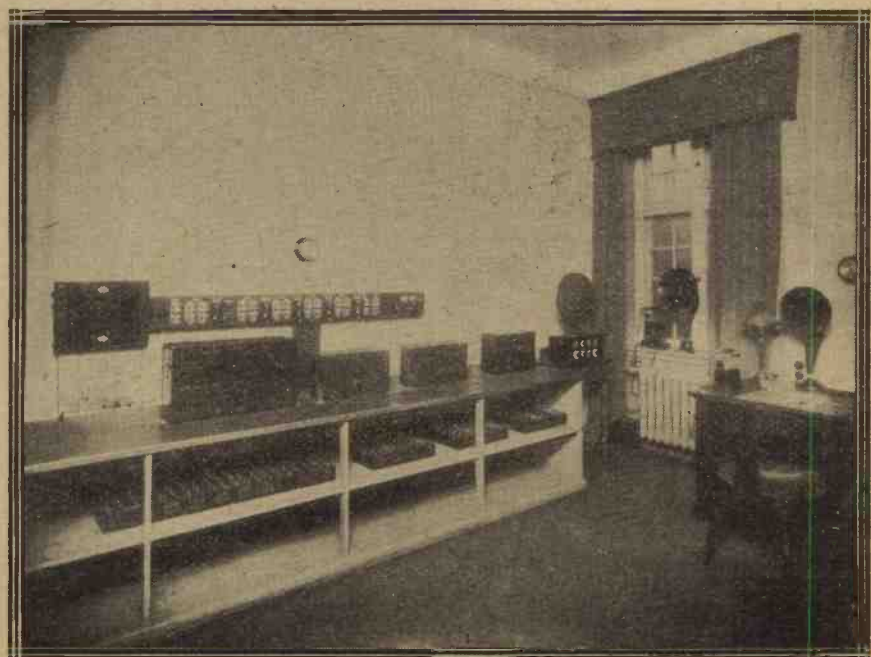

The control room of the Yorks Passage station, Copenhagen.

Another great contribution to the Science of Radio by Cossor

Red Top :
For H.F. use.

Plain Top :
For Detector
or L.F. use.

15/6

For 2-volt
Accumulators.

The new Cossor Point One

—the '1 amp. Valve which
utilises Co-axial Mounting

**Cossor
Stentor Two**
Power Valve
Consumption '15 amp

18/6

For 2-volt
Accumulators.

IT was a flash of genius that enabled Simpson eighty years ago to discover chloroform. Genius, too, helped James Watt to read the lesson of the steam engine in the escaping steam from his mother's kettle. Assuredly it was genius that caused Montgolfier to visualise in the floating remnants of a burning paper bag the world's first balloon—the prelude to man's conquest of the air.

And once again a touch of genius has been responsible for an entirely new method of valve construction that bids fair to produce results which, but a year ago, would have been considered impossible.

The new series of Cossor valves employ—for the first time in the history of Radio—a method which, accurately and for all time, ensures perfect alignment for the filament, grid and anode. At the same time it provides a shockproof support for the filament.

Thus throughout the whole life of the valve its working characteristics cannot alter. Age cannot cause filament sag nor can hard wear disturb the exact relative positions of the filament, grid or the anode.

But this is not all. The improved Cossor filament consumes but a moiety of the current required by other Dull Emitters—its consumption at 4.8 volts being barely one-tenth of an ampere. A seven-valve Super Heterodyne, for example, using these new Cossor Point One Valves would not con-

sume as much current as a little one-valve set using a single bright emitter.

As can be imagined, the filament used in this new Cossor is no ordinary filament. Owing to its exceptional length and its scientific method of preparation a great latitude in working voltages is permitted. Satisfactory results are obtainable at a voltage as low as 1.2, so that the valve can, if required, be used with dry cells. Further, its operating temperature is lower than that of any other valve on the market. And everyone knows that low temperature means long life.

The Cossor system of Co-axial Mounting has now finally abolished the last bug-bear of dull emitter valves—microphonic noises. Individual movement of either the grid or the anode in the Cossor Point One is utterly impossible. The selenite insulator holds them both in a vice-like grip which defies the hardest shock.

With its handsome pipless glass bulb, its re-designed low loss moulded base, and its new positive contact pins the introduction of these new valves represents one of the most important events in the progress of the Valve. See your Dealer about them to-day—we can promise you new delights in radio reception. A greater economy, improved sensitivity, a wonderful richness of tone, with a length of life and uniformity of performance which will positively astonish you.

Cossor Valves

—The new Dull Emitters with the long-life '1 amp. filament.

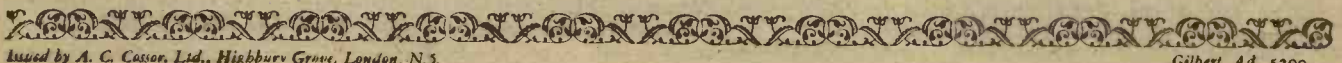

IN SCANDINAVIA WITH A SUPERHET—continued

in the morning, is, like the other Swedish stations, a model of efficient construction and working. The well-appointed studio is, for the convenience of the artistes, in the centre of the town, but the transmitting gear, which I was also able to inspect, is installed in a compact concrete building situated some two or three miles out of the city, open to the winds of heaven on



The artistes' waiting room at the York's Passage station.

the high plateau which extends for miles in this direction.

The station is under the direction of Doctor Rabe, a distinguished personality in the city, and is considered by some to be the best provincial station in Sweden. It is perhaps unique in having created a special department to deal with the broadcasting of scientific and literary lectures, which are greatly appreciated by listeners in the district.

A Reluctant Farewell

I was reluctantly obliged, to leave Gothenburg in the afternoon, after a most interesting visit, and proceed to Copenhagen on my way to Berlin, which I was due to visit before my return to England. I departed in the hope of revisiting Scandinavia at some future date, in summer weather, when during the long hours of summer daylight I might renew my acquaintance with the many delightful people and interesting places I had seen on my winter visit. In the delightful summer climate for which these countries are famous, I am looking forward to a revisit to Scandinavia, still accompanied, of course, by my trustworthy friend, my "Super-het."

USING THE MAINS FOR H.T. AND L.T.

SIR.—I have read with interest the article in the July issue of THE WIRELESS CONSTRUCTOR on the subject of the possible sources of H.T. supply. The writer of this article, in discussing the use of direct current mains of higher voltage than required for the H.T. supply to the receiver, mentions the

potentiometer method of obtaining any desired voltage up to maximum possible and describes this as being uneconomical. With this view I am in agreement, but I think that it will possibly be of interest to you and to your readers if I give you a few details of a system of using the D.C. mains which I reckon to be quite economical.

Briefly the system consists in placing a group of lamps of suitable resistance in series with the valve filaments, which are themselves in series. In this way the consumption of current by the valves is kept low. The H.T. supply is obtained by taking tapplings as required between the lamps, utilising the voltage drop across the lamp filaments to obtain the necessary H.T. voltages for the valve anodes. The current taken for the H.T. supply is of course small, and the whole system cannot, I think, be considered wasteful. The mains in my case are 220 volts D.C., so that I have an ample H.T. voltage for any purpose.

Wishing THE WIRELESS CONSTRUCTOR every success, I am,

Yours faithfully,

JAMES C. ANDERSON.

Nottingham.

AN EASILY MADE FRAME AERIAL

IT is often necessary to construct a frame aerial hurriedly to enable certain tests to be carried out, and the method indicated below has proved very satisfactory and has the advantage of cheapness combined with simplicity. The material required is an ordinary wooden hoop, two dowel rods each about 2 ft.

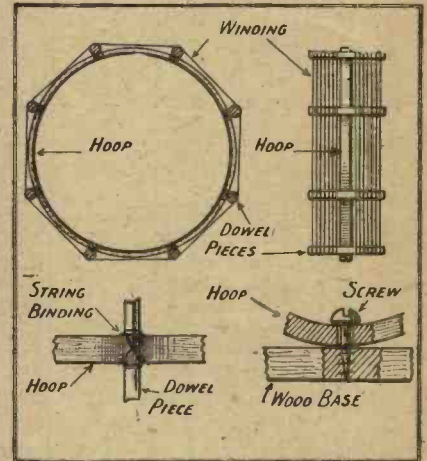

The construction can readily be seen from these details.

long and 1/4-in. diameter, some string, and a quantity of insulated wire.

Simple Construction

The whole of the construction of this frame aerial may be carried out in the space of half-an-hour. First cut off eight pieces of dowel rod, each piece being 6 in. long. Tie these to the wooden hoop as shown in the diagram, and then wind the wire on the cross-pieces, evenly spacing the turns. By equipping the beginning and end of the winding thus made with suitable leads and securing the hoop itself to a small wooden base, the aerial is ready for the test purposes. A suitable method for securing the hoop is to pass a wood screw through a hole drilled in the hoop and into the base piece. This enables the aerial to be turned as desired if the screw fit is not a tight one.

A frame aerial of this type was made by the writer and was found to give extremely satisfactory results.

ALL EUROPE ON A FRAME AERIAL

See this month's *Modern Wireless*
NOW ON SALE PRICE 1/-

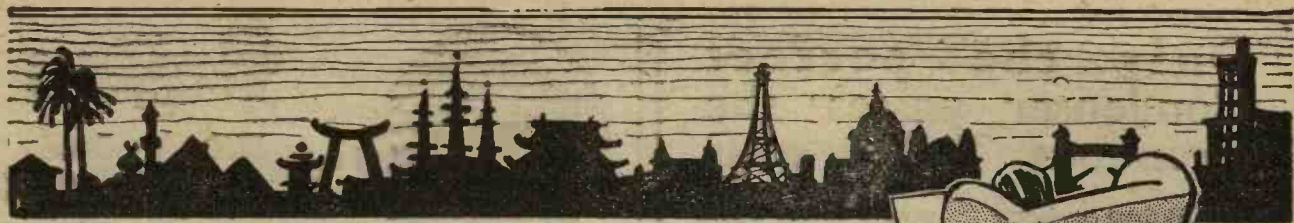

The World's Wireless Programmes in your own Home

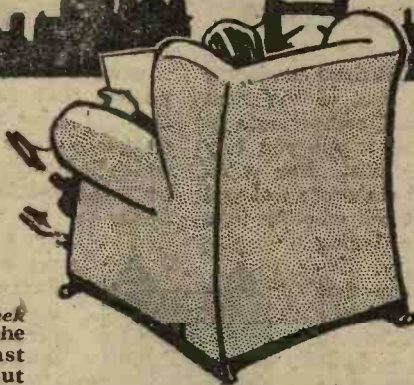

"WORLD-RADIO" is the only journal which tells listeners a week in advance about Dominion and Foreign programmes. It brings the outside world's broadcasting to Britain and keeps listeners abreast of the times with interesting and up-to-date information about international broadcasting. Another outstanding feature of this companion paper to "Radio Times" is an accurate table of stations abroad, in the order of wave lengths, which makes it the essential paper for the enthusiastic listener.

On sale at all Newsagents and Book-stalls every Friday, 2d., or by post (one year's subscription 13/6) from the Publishers, George Newnes, Ltd., 8-11, Southampton Street, Strand, London, W.C.

WORLD-RADIO

WITH WHICH IS INCORPORATED  "THE RADIO SUPPLEMENT"

DESIGNED SPECIFICALLY FOR BUILDERS OF THE "ELSTREE SIX"

So that the countless experimenters who invariably prefer to use J.B. Condensers in all their receivers may incorporate them in the "Elstree Six," we announce the introduction of .0005 J.B. low loss twin condenser.

The design adheres to the type here illustrated (.02 ohms loss at a million cycles certified by the M.P.C.) in addition to the other essential features which characterise the J.B. to give the utmost tuning efficiency.

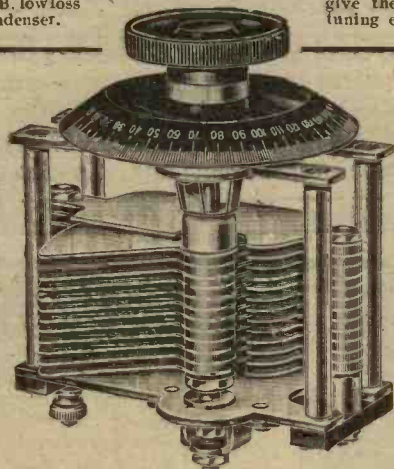

J.B. LOW LOSS GEARED FERMIER (60 to 1).
 .001 - 17/6
 .00075 - 16/3
 .0005 - 15/-
 .0003 - 13/6
 .00025 - 12/6
 .0002 - 11/-
 .0001 - 10/-
 [Pat. No. 246009]

J. B. LOW LOSS.
 .001 - 13/-
 .00075 - 11/6
 .0005 - 10/6
 .0003 - 9/-
 .00025 - 8/6
 .0002 - 8/-
 .0001 - 8/3

Pat. Nos. 241803 and 246309

J.B. low loss Twin Condenser for the "Elstree Six" .0005 mfd. 21/- each; £4 for the set of four.

JACKSON BROS.

8, POLAND ST- OXFORD ST Telephone: GERARD 7414
 LONDON - W.1 (First Floor)

Agents for Holland: Radio Beurs, Papestraat 8, Sgavenhage, Hague, Holland.

EFESCA

Regenerative AERIAL TUNER

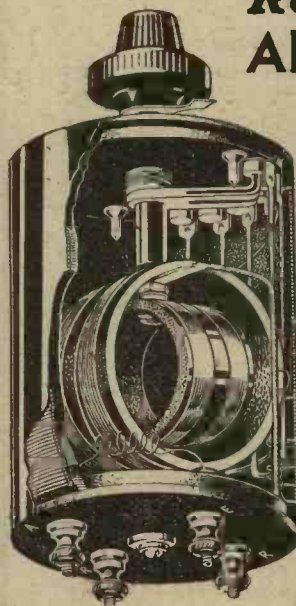

The Efesca Regenerative Aerial Tuner is a specially designed form of Tapped Aerial Coil incorporating Aerial Reaction in a self-contained Unit.

Reaction is effected by means of a rotor revolving in a separately wound section of the Aerial Coil, thereby effecting maximum reaction over the whole wave band covered by the coil. Wavelength range 150 to 2,600 metres in conjunction with a .0005 variable condenser in parallel.

Complete with Knob, Pointer and Scale

Price 35/- each

Ask your Wireless Dealer or Electrician for

EFESCA
COMPONENTS

Write for Catalogue No. 559/4 describing and illustrating EFESCA COMPONENTS

FALK STADELMANN & CO., Ltd.

83-93, Farringdon Road, London, E.C.1
 ALSO AT GLASGOW, MANCHESTER AND BIRMINGHAM

Only the perfect Condenser passes the strenuous T.C.C. tests

YOUR fixed condenser is one of the most vital components in your set; yet you buy it on faith. For without an elaborate test you cannot tell whether it is functioning correctly. Experts say that the majority of faults in home-built receivers are traceable to the use of inferior and badly insulated condensers. It is false economy to buy an unknown condenser, for although you save perhaps a few pence in the first place, it eventually becomes much more costly when breakdown occurs. Only by producing Condensers which give absolute satisfaction can T.C.C. hold their good name. When you buy a T.C.C. Condenser you know that

you have chosen a component that because of the strenuous and elaborate tests through which it has passed, can be indefinitely relied upon to be not only break-down-proof but to have an almost negligible percentage of error. Look through the files of any of the technical Wireless papers and you'll find repeated testimony to the quality of the T.C.C.—its specification in circuit after circuit by experts who know. Can you afford to overlook this Condenser—renowned for its accuracy and dependability—for one of doubtful origin and still more doubtful qualities. Do as the experts do—specify T.C.C.



Here is the range:

Mansbridge, 2 mfd. - 4/8	Mansbridge, 1 mfd. - 2/6
Mansbridge, 1 mfd. - 3/10	Mansbridge, '09 to '01 - 2/4
Mansbridge, .5 mfd. - 3/4	Mansbridge, '009 to '005 - 2/-
Mansbridge, .4 mfd. - 3/2	Mica, '004 to '001 - 2/4
Mansbridge, .25 mfd. - 3/-	Mica, '0009 to '0001 - 2/4



T.C.C. Condensers (Mica and Mansbridge)

Manufactured only by:
Telegraph Condenser Co., Ltd.,
 Wales Farm Road, N. Acton, W. 3.

Gilbert Ad. 5326.



Obtainable from all Dealers

Finston SUPER COILS

Are totally enclosed in moulded Bakelite cases giving great mechanical strength, without impairing their efficiency.

The coils have been so constructed that the centres are always in alignment when two or more are used, thereby securing maximum results from their magnetic field.

All connections are soldered so as to give constant electrical continuity throughout.

A loose plug is provided so that the winding of the coils can be reversed if so desired.

Prices:—25, 55, 40, 2/6 each; 50, 60, 3/- each; 75, 100, 150, 3/6 each; 175, 200, 4/- each; 250, 300, 4/6 each.

FINSTON MANUFACTURING CO., LTD.,
 45, HORSEFERRY ROAD, WESTMINSTER, LONDON, S.W.1.

Parrs Ad.





RADIO COMPONENTS OF ADVANCED DESIGN

NEW CATALOGUE NOW READY

THE FORMO COMPANY
 Crown Works, Cricklewood, N.W.2

10/6 Fully Guaranteed.
 All Ratios. 1-1 to 1-5.

Don't forget to use

GLAZITE

BRITISH MADE REGD.

COLOURED CONNECTING WIRE

[RED · YELLOW · BLUE · BLACK · WHITE and GREEN]

Write for descriptive leaflet to
The LONDON ELECTRIC WIRE CO. & SMITHS LTD.
 Playhouse Yard, Golden Lane, London, E.C.1.

Makers of Electric Wire  *for over 40 years*



ABSOLUTELY NON-MICROPHONIC!

At last the perfect valve holder! The Etherplus + "Antivibro" Valve Holder has low capacity legs in a soft rubber base, which in turn is mounted on four phosphor bronze springs inside a high quality moulding.

Price 2/6

From dealers or from
MANDAW 9-15, Whitecross Street, London, E.C.1



RADIO ACCESSORIES
 — ENSURE PERFECT RECEPTION



CHANGE YOUR COIL AND CHANGE YOUR CIRCUIT

By Stanley G. Rattee. M.I.R.E.

THE attractive properties possessed by the Reinartz circuit are too well known to comment upon, and it is a modified version of this circuit which is primarily used in the receiver to be described. The chief merit in the present case is that by the use of special coils it is possible to change the circuit of the set, from a modified Reinartz arrangement for reception upon the ordinary broadcast band of wavelengths, to a direct-coupled aerial circuit, employing straightforward variable magnetic reaction for reception upon the longer wavelengths.

In order that this change may be made, all that is actually required is to change the plug-in coil; no switches or jacks are involved, the change-over of connections being automatically brought about by the arrangement of the plug-in-coil unit.

The Circuits Used

An examination of the Fig. 1 circuit will show that the arrangement in the first case greatly resembles,

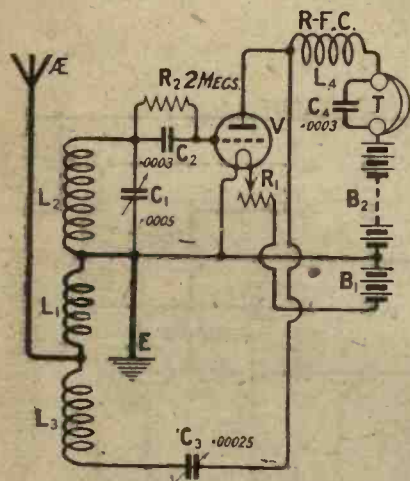

Fig. 1. — This arrangement of the receiver resembles the Reinartz circuit. as stated above, the Reinartz circuit, while Fig. 2 shows the connections of the actual receiver. The let-

ters AE, E, G, C, A, TC, T and OUT are those marked upon the coil-holder (seen in the photographs), secured to the baseboard, while the dotted lines show how the actual coil unit completes the connections, when pushed into position.

Constructional Design

As to the construction of the set, the upright panel and baseboard arrangement has been adopted, as in this particular case the wiring requirements are greatly simplified by so doing.

.....

Fig. 2.— The actual connections of the receiver are shown in this diagram.

.....

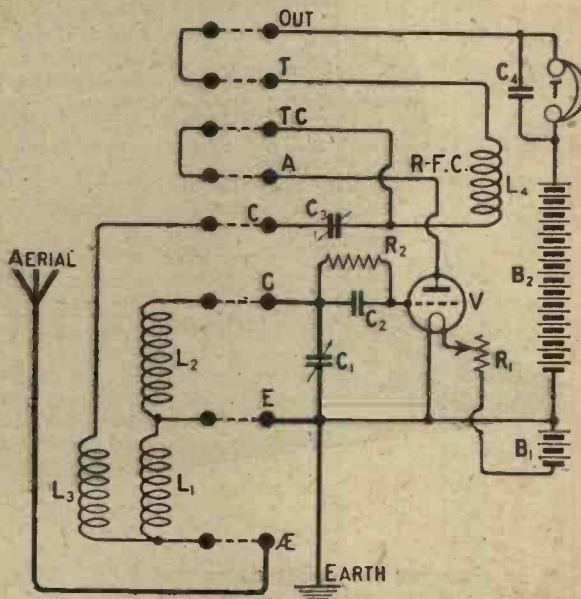

By following these connections it will be found that the result is to produce the circuit of Fig. 1, the various reference letters of the symbols being the same in both cases.

The Change-Over

In the case of long-wave reception the circuit used is that of Fig. 3, while the connections brought about by the plugging in of the long-wave coil are as shown in Fig. 4. The connections within the set and made to the coil-holder, of course, remain the same, while those of the coil unit itself are as indicated.

The variable coupling between L1 and L2 is given by a knob attached to the top of the coil unit, the reaction coil being contained within the casing of the unit.

Looking at the receiver from the front the only components mounted thereon are the grid tuning condenser (left), the filament rheostat and the reaction condenser (right). For reasons of easy operation "slow motion" variable condensers are used, while easy access to the terminals is given by these being also fitted to the front of the panel.

The coil unit, valve, and so on are all contained within the cabinet, which should, of course, be fitted with a hinged top to allow the interior of the set to be quickly attended to when it is desired to change the coil.

Wavelength Range

The flexibility of this receiver is such that not only may reception be made upon the broadcasting wave-band and upon the long wavelengths,

"Change Your Coil and Change Your Circuit"—continued

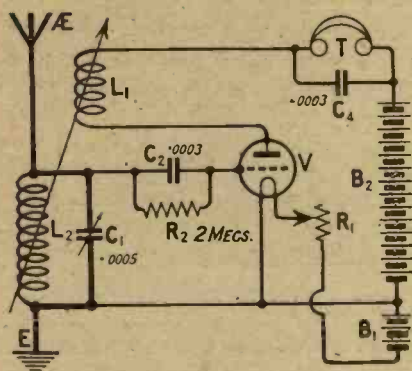

Fig. 3.—The receiver is shown here as arranged for reception on the longer waves.

duplicate the set in every detail, though it will, of course, be understood that other suitable makes may be found in the advertisement pages of this journal.

In so far as the values are concerned, it is not recommended that these be departed from, for, in order that the most suitable values may be decided upon a considerable amount of experimental work has been gone through in all cases of receiver design, and if this effort on the part of an author is to be ignored, then the defaulting reader has only himself to blame if the set does not cover the desired wavelength range, or develops some other undesirable feature:—

One ebonite panel measuring 14 in. by 7 in. by $\frac{1}{4}$ in. ("Paragon").

One cabinet to panel dimensions, and baseboard ("Camco").

Two variable "slow motion" condensers, .0005 and .00025 (Radio Instruments, Ltd.).

One gridleak and condenser, two megohms and .0003 respectively (Dubilier Condenser Co., Ltd.).

One fixed condenser, .0003 (Watmel Wireless, Ltd.).

Eight terminals.

One filament resistance, 30 ohms ("Kay-Ray").

One valve holder ("Etherplus").

One coil-holder, board mounting-type (Beard & Fitch).

Set of special plug-in coils and base (Beard & Fitch).

Two right-angle brackets ("Magnum").

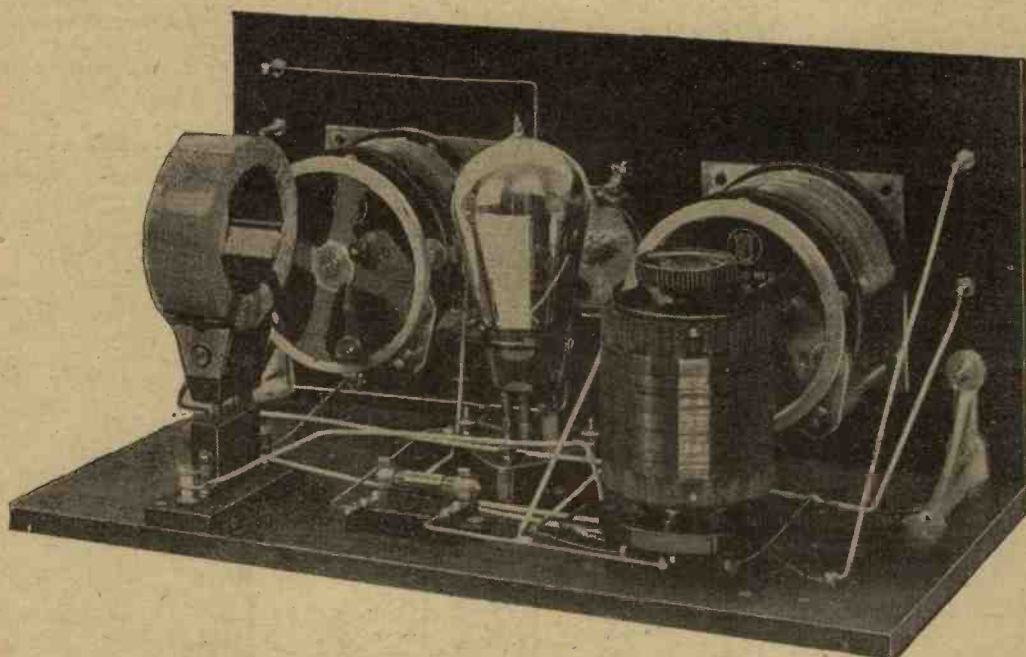

.....
A plug-in coil is used as the radio-frequency choke.
.....

but by changing the coil unit to one containing fewer turns, then reception may be made upon the relatively short waves.

These coil units are of commercial manufacture, and are of three sizes, namely, sizes suitable for reception upon relative short waves, the broadcast band and long waves; the coil-holder is common to all three, yet each coil makes a complete receiver capable of receiving over a definite wavelength range.

Components and Materials

Those readers who desire to build a receiver of this type should first of all collect the following material and components. It will be found that following upon the names of these, the names or trade marks of the manufacturers are also given. The purpose of giving this information is merely to assist those readers who wish to

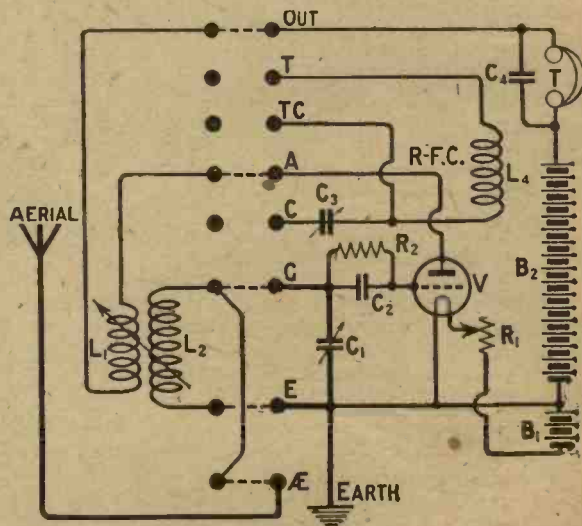

.....
Fig. 4.—The method of arranging the receiver for the circuit of Fig. 3 is shown here.
.....

"Change Your Coil and Change Your Circuit"—continued

Quantity No. 16 "Glazite" connecting wire.

Packet Radio Press panel transfers.
One No. 300 plug-in coil (to serve as a radio choke).

exercised when wiring up the coil holder, and for the guidance of readers the following procedure should be adopted:—

The first connection to be made

The remaining connections are perfectly straightforward, and may be clearly understood from the wiring diagram.

Testing the Receiver

When the wiring has been completed and carefully checked against the wiring diagram as published, insert the coil suitable for the broadcasting band of wavelengths in its holder, insert an ordinary No. 300 plug-in coil in the ordinary coil holder, turn the filament resistance to its "off" position, and insert a valve in the holder. Connect the telephones and L.T. battery to their appropriate terminals, when by slowly turning the filament resistance the valve should light up, its brilliance being controlled by the position of the arm of the rheostat.

Having satisfied oneself upon this point, disconnect the L.T. supply, and connect it across H.T. negative and H.T. positive terminals, noting that the valve does not light irrespective of whether the filament resistance be on or off.

Operating and Adjusting

If these preliminary tests have proved satisfactory, connect the L.T. across its proper terminals, and about 45 volts across the H.T. terminals, still keeping the special plug-in coil

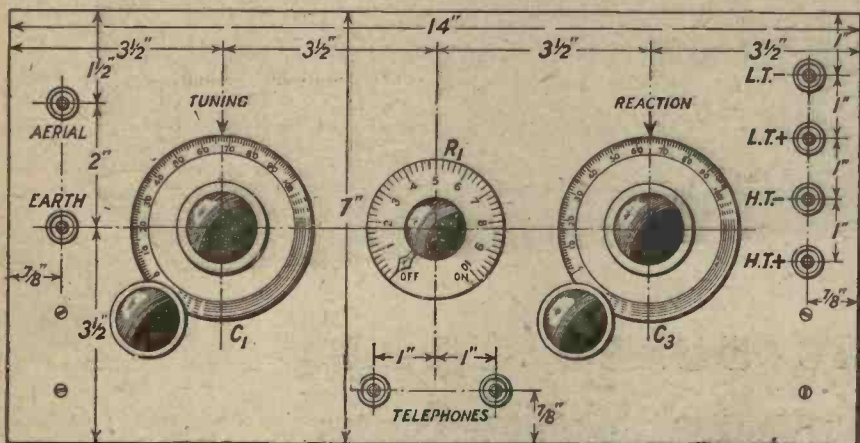

Fig. 5.—The tuning controls are placed in positions which make for ease of handling. (Blueprint No. C1056A).

Mounting the Components

The drilling and preparing of the panel for mounting the components is so simple that this work does not require any further information than that given in Fig. 5. When this has been done the baseboard and panel are secured together in the ordinary way by means of the brackets, whereupon the components may be mounted.

Regarding those to be secured to the baseboard the layout indicated in the photographs and wiring diagram, Fig. 6, should be followed as near as possible.

An Important Detail

Before fixing the coil-holder to the baseboard by means of the three screws provided for the purpose, it is advisable to first solder short lengths of soft tinned copper wire to the tags, as should this not be done it will be found rather difficult to make the required connections to the remainder of the components involved, there being little room between the baseboard and the under-side of the holder when the latter is screwed down.

In the receiver as illustrated these connections were simplified by first soldering about 2 in. of No. 22 wire to each of the tags before screwing the holder in position and arranging these wires so that they projected beyond the ebonite base, any surplus of wire being subsequently cut off.

Wiring the Set

The operation of wiring up should present no difficulty, as there is plenty of room allowed between the components for even a large soldering iron to be used. Care should, however, be

exercised that between "OUT" of the coil holder and one of the telephone terminals, and one side of the .0003 fixed condenser; this should be followed by connecting "G" to one side of the grid-leak and condenser.

The remaining connections should be made in the following order:—"E"

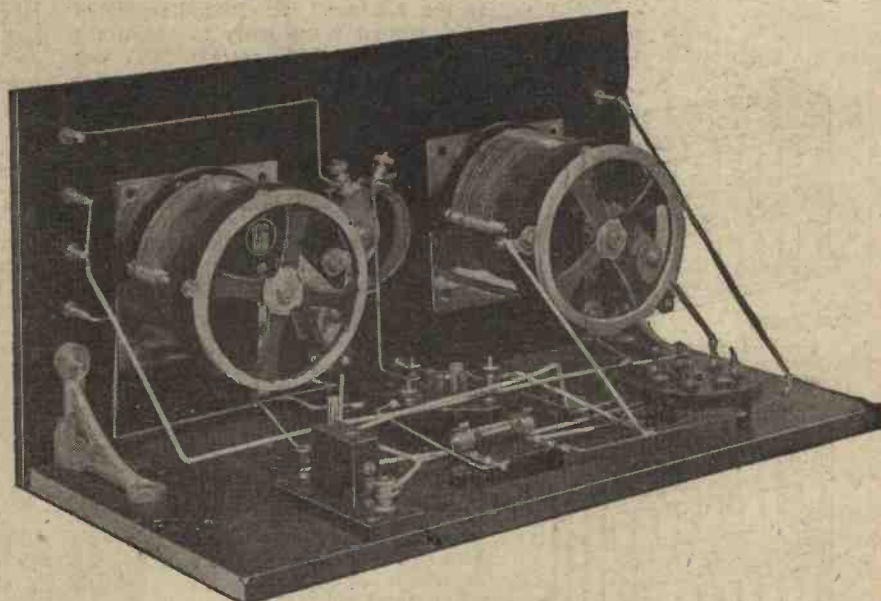

The wiring is very simple in character.

to L.T. positive, "Æ" to the aerial terminal, "A" to the anode leg of the valve holder, "C" to the fixed vanes of the .00025 variable condenser, "TC" to the moving vanes of the .00025 variable condenser, and one side of the coil socket which will eventually hold the radio frequency choke, and the other side of this socket to "T."

in position as before; no aerial or earth being connected, however. Set the grid tuning condenser (C₁) to some nominal value, and set the reaction condenser (C₂) to its zero reading, whereupon the valve may be lit to a suitable degree of brilliance and the reaction condenser slowly turned so that its reading is increased.

The only H.T. Accumulator built on the principles of the expanding Bookcase

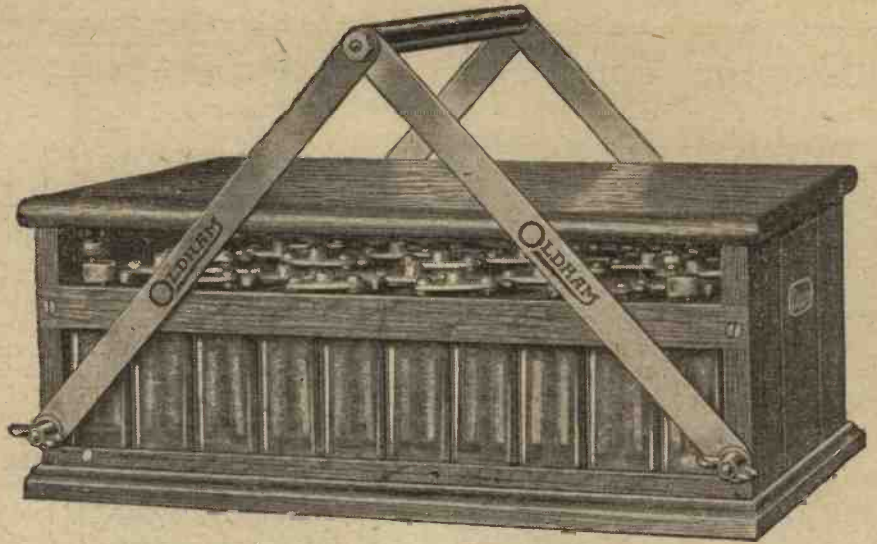

The Unit

Each unit consists of 10 glass cells making a total of 20 volts. Each individual cell can be tapped—thus ensuring extreme flexibility of voltage control. A stout oak framework protects the cells against damage.

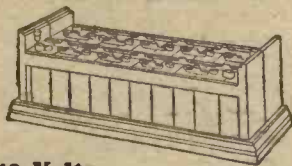

40 Volts

For 40 volts two units are required clamped side by side and mounted on a handsome solid oak base. For 60 volts as in large illustration above three units would be required.

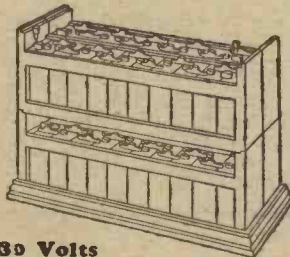

60 Volts

Two tiers of two units each are required. The same base and lid are used as for 40 volts.

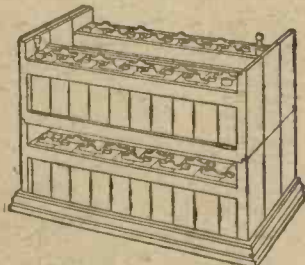

100 Volts

Two tiers are used—the bottom one containing 3 units and the upper one containing only two units with blank end pieces to separate them. For 120 volts the end pieces are removed and a complete unit is substituted.

Put some "pep" into your Wireless Set

If your Receiving Set seems to have lost some of its vitality—if it is not so responsive to weak signals as it used to be—if foreign stations are more difficult to pick up—if the local station has fallen off in quality and volume—if cracklings and sizzlings are the usual accompaniment to every programme—then suspect our old friend the H.T. Dry Battery. In all probability he is the offender. A plentiful supply of H.T. current is necessary to obtain the best results. The average H.T. dry battery will lose voltage steadily even if unused. How rapidly then will its

voltage fall if it is used with a big multi-valve Set. Wireless enthusiasts all over the country are discarding their H.T. dry Batteries and changing over to the wonderful new Oldham H.T. Accumulator. And immediately they are obtaining an amazing improvement in reception. The Loud Speaker takes on a new standard of tonal purity—stations which couldn't be heard at all are received at full strength, cracklings and noises entirely disappear. This wonderful change is entirely due to the unfluctuating flow of H.T. current which only an Oldham Accumulator can give.

Stop wasting money on Dry Batteries—invest in an Oldham H.T. Accumulator instead

You waste money every time you buy a Dry Battery because it can never be recharged. And when you buy it you don't know how long it has been in stock. A dry battery starts working the moment it is made. Not so an Oldham H.T. Accumulator. When you choose an Oldham you buy wisely—you get long service. An Oldham will last for years. It can be recharged for a shilling or two again and again. It will save its cost very quickly. But if you want the best results be sure it is an Oldham for only Oldham has the Special Activation Process—the method which ensures a plate holding its charge for several

months without the risk of sulphation. Only Oldham has the expanding unit idea. You can buy your units just as you require them and add to your voltage with the minimum of expense. Look at the compactness and convenience of the Oldham H.T. Accumulator shown above. Note its extreme portability and workmanlike appearance. Observe its stout glass cells—each one is instantly available for examination—and its thick buckleproof plates. Then go to your Dealer and ask him to show it to you—we are confident you'll never use another H.T. Dry Battery.

10d. per volt

40 volts	£1 13 4	60 volts	£2 10 0
80 volts	£3 6 8	100 volts	£4 3 4
		120 volts	£5 0 0

Complete with lid and handles. Solid oak base 3/6 extra if required.



Oldham & Son, Ltd.,
Denton, Manchester.
London: Hazlitt House,
Southampton Bldgs., W.C. 2.
Manchester: Looker's Ltd.,
Deansgate.
Glasgow: 120 Wellington St.
Gilbert Ad. 6314.

“Change Your Coil and Change Your Circuit”—continued

Self-Oscillation Details

Proceeding in this manner will soon result in the set bursting into self-oscillation, and should this condition come about by a loud “plop” in the ‘phones, the value of the H.T. voltage should be reduced until the “plop” becomes only weak in strength, whereupon reducing the filament current will reduce the “plop” still more until a point is reached where the set will not oscillate at all.

Adjust the filament current so that the set will only just oscillate at all settings of the C_1 condenser (it should be noted that as C_1 is increased so must the reading of C_2 be increased to keep the set in its most sensitive condition), and connect the aerial and earth.

The First Signals

It may now be noticed that the receiver will not oscillate at all, where upon the value of the H.T. voltage should be increased slightly until the smooth control reaction previously ex-
(Continued on page 926.)

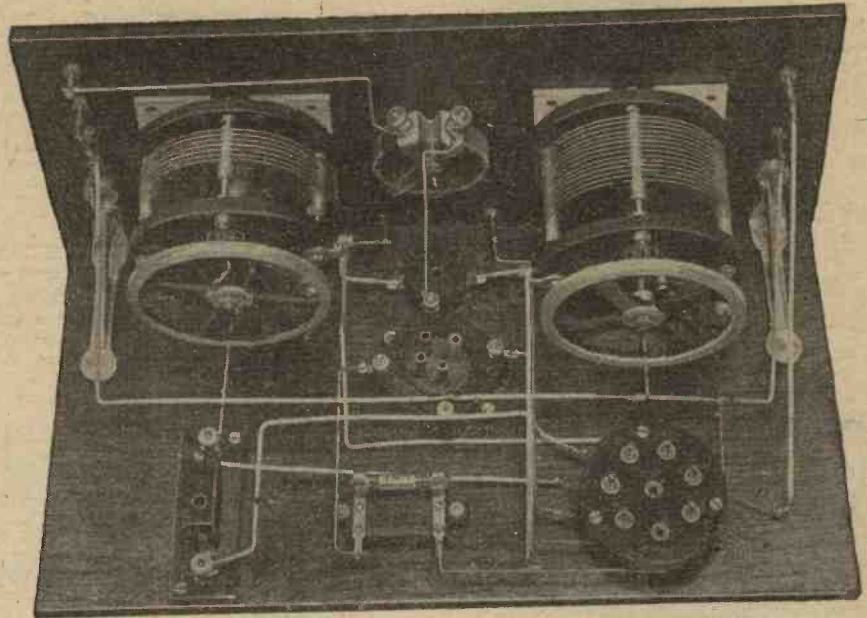

The coils are kept well away from other components.

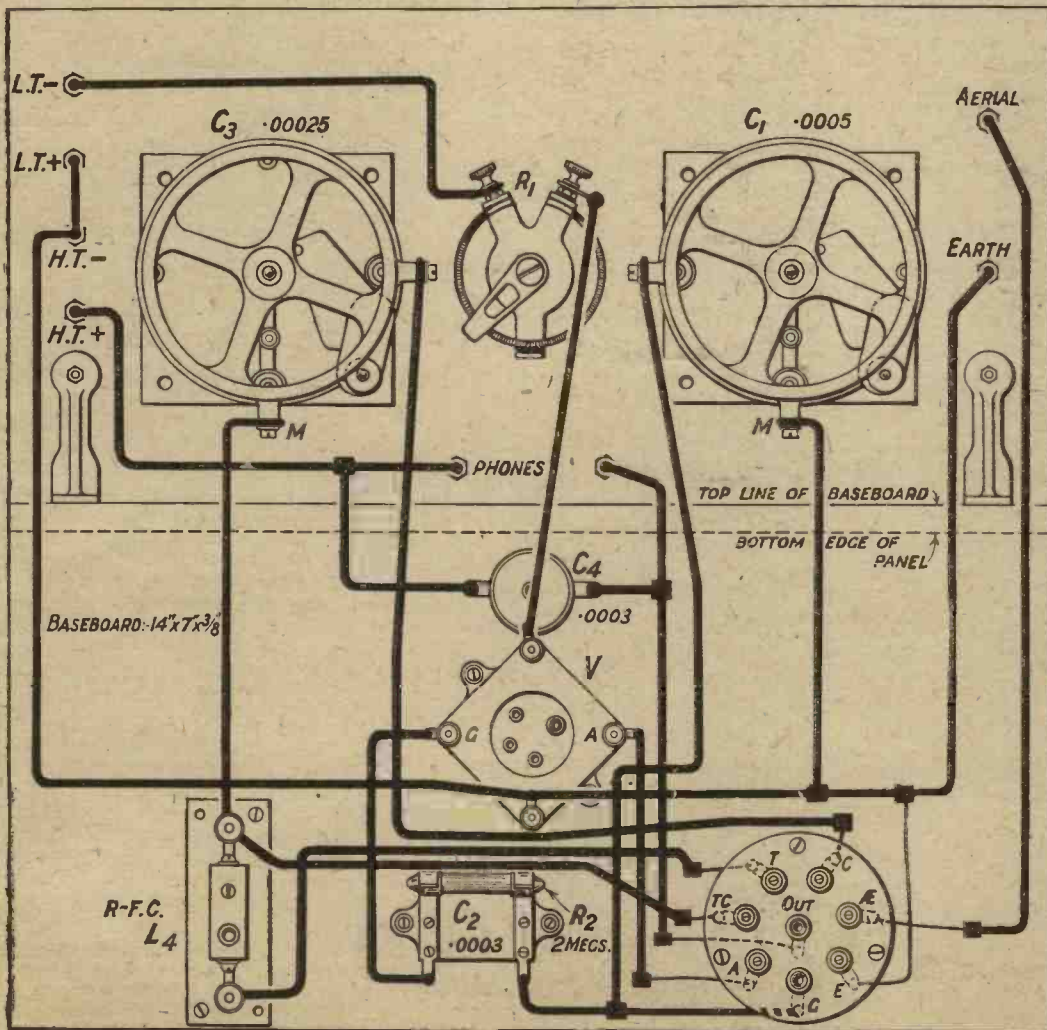
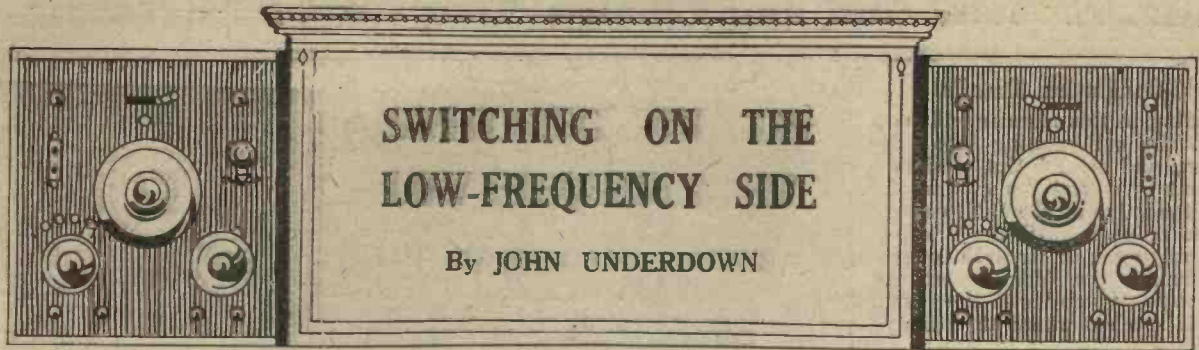

Fig. 6.

The method of making connection to the coils is quite clear from this diagram. (Blueprint No. C1056B).





You can add a number of refinements to your set by arranging to utilise a varying number of low-frequency stages.

IN last month's article attention was devoted chiefly to rotary stud and multi-pole 2-way switches, so this month it is intended briefly to deal with the application of jacks, but before so doing a further use for a 3-pole 2-way switch, which I have been asked to give, will be shown.

A Further Application

Where it is desired to employ telephones with two valves, for example, for tuning purposes, or to listen on the loud-speaker on the three, a very convenient arrangement is that of Fig. 1. Here a 3-pole 2-way switch is so wired that when working in the upward position, that is, on two valves, the last valve is extinguished and the telephones are brought into circuit. On placing the switch in the 3-valve position the H.T. connection to the detector valve is made through the primary winding of the L.F.

transformer T_1 , this valve still receiving its correct high-tension supply, from H.T. + 1, and the loud-speaker is brought into operation.

Plug and Jack Switching

Plug and jack switching has come

observed are indicated in Figs. 2 and 3.

The circuit of Fig. 2 is that of a 4-valve receiver with two resistance-coupled note magnifiers, it being arranged, by means of three jacks, J_1 , J_2 and J_3 , to listen on the detec-

The simple stud switch is useful on many occasions.

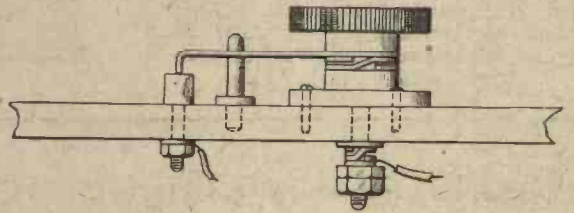

into much greater vogue during the last few months than it had in the earlier days of broadcasting, being very convenient in use, and is generally quite simple to wire. Various applications and practical points to be

observed are indicated in Figs. 2 and 3. J_1 is a "closed-circuit" jack, and its connections here are somewhat interesting, in that the anode resistance R_0 is in series with the telephones when tuning is accomplished when the last two valves are out of circuit.

An Important Detail

This is a practical point which should be noted, since if it is arranged by means of a double-circuit jack to cut the resistance out of circuit, when the telephone plug is withdrawn R_0 will replace these, and consequently, since the ohmic resistance of the telephones is small, a drop in the voltage applied to the anode of the detector valve V_2 will occur. If the set is carefully adjusted to be working just below the oscillating condition, this drop in applied H.T. voltage may be sufficient to render it far from this sensitive state, making readjustment of the potentiometer or reaction setting necessary to bring up signal strength.

Telephones or Loud-Speaker

J_2 is a "double-circuit" jack, and when the telephones are inserted therein and V_4 is switched off on its filament resistance R_1 , the set functions as a three-valve receiver.

J_3 is a further double-circuit jack incorporated in the anode circuit of the fourth valve, and is wired in a somewhat interesting manner. With no telephones inserted, the loud-speaker is in operation, whilst this

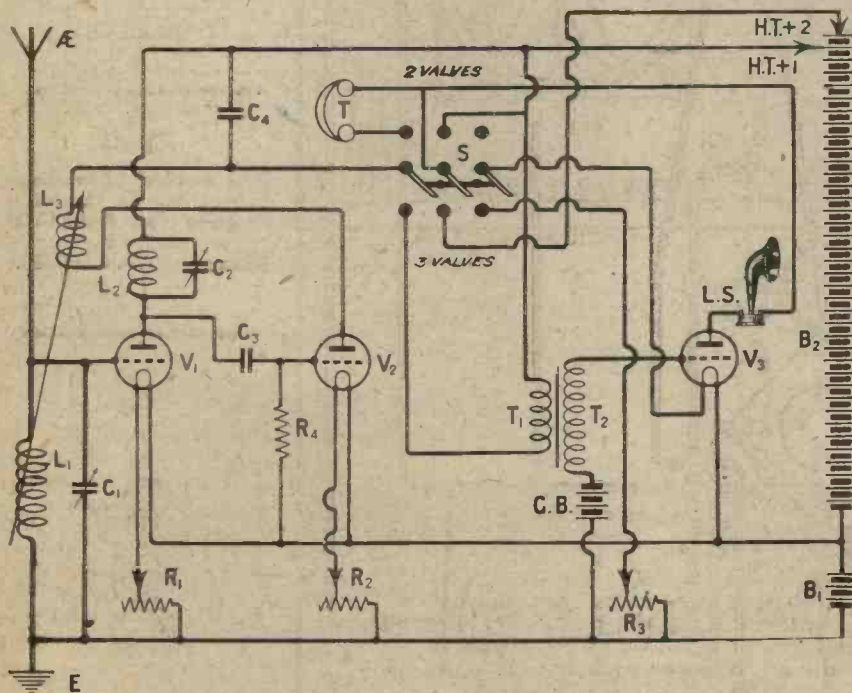

Fig. 1.—A three-pole change-over switch is required in this circuit.

Switching on the Low-Frequency Side—continued

latter is thrown out of use on the insertion of telephones.

Introducing Complications

Fig. 3 illustrates the employment of rather more complicated types of

sitated thereby is somewhat complicated, and my own personal preference is for the employment of the simpler types of jacks, the valves not required being switched off on their own filament resistances.

the wiring very complicated. Although there is less risk of introducing instability by incorporating some switching system on the L.F. side, than on the H.F. side of a receiver, the fact that unduly complicated wiring may

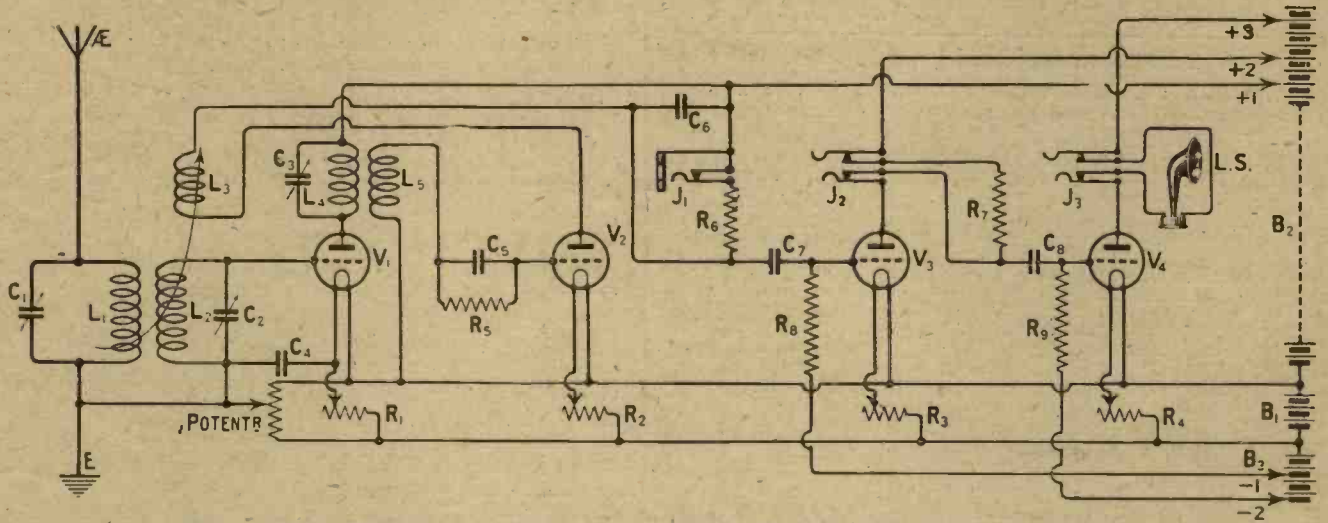

Fig. 2.—Jack switching is employed here to cut out the L.F. valves when not required.

jacks, which are arranged to switch the filaments as well as the anode circuits of various valves. Jacks 1 and 2 are "filament-control double-circuit" jacks, and J₃ is a "filament-control single-circuit" jack. The insertion of a telephone or loud-speaker plug into J₃ lights and brings all three valves into use. Inserted into J₂, the last valve is extinguished and only two are in circuit, whilst in J₁, V₁ and V₂ are

General Considerations

In deciding upon the system of switching to be employed on the low-frequency side the beginner often experiences difficulty in making his choice, but by considering the examples given both the advantages and the limitations of the three types dealt with should be fairly clear. My considered advice is always adopt the

lead to oscillation at low frequency should not be overlooked.

Important Points to Note

Where it is desired only to cut one valve out of circuit, generally the simplest type of switch to employ is one of the rotary stud type, but here

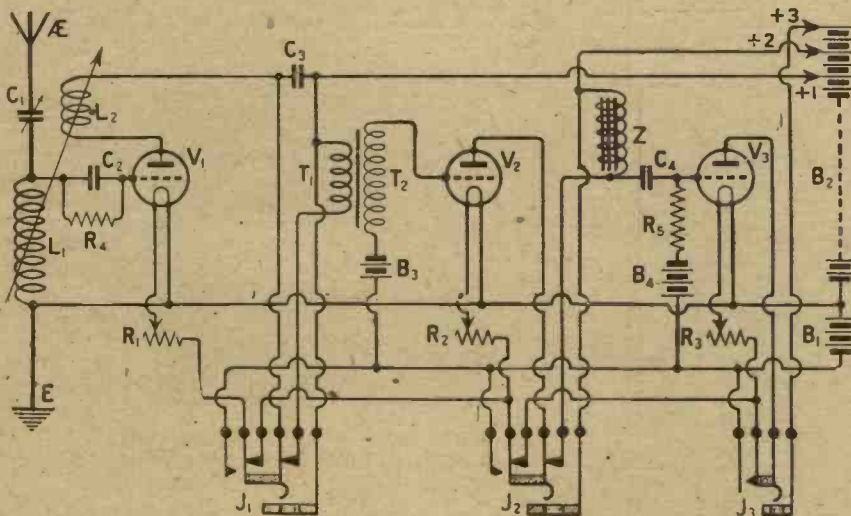

Fig. 3.—In this arrangement the jacks also switch the filaments on or off.

extinguished, and only the first valve is employed.

The arrangement of Fig. 3 is a very convenient one, but the wiring neces-

simplest possible system, and do not allow the more spectacular arrangements to unduly prejudice you into utilising switching which will make

the valve not required will have to be extinguished upon its own filament resistance, unless a further stud switch is incorporated. Generally, this type of switch will not operate simultaneously in both anode and filament circuits.

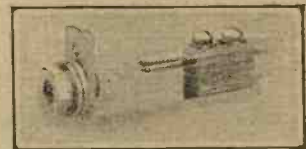

A simple type of jack.

Switching the Filament

In cases, therefore, where it is required both to cut a valve out of circuit and to cut off its filament supply simultaneously, a 2-way switch of multi-pole type is to be recommended. Such switches, in the writer's opinion, are not suited for the work where several valves will be cut out of circuit, one at a time, and it is here that the plug and jack system makes its appeal.

OUR LATEST MODEL

STRAIGHT LINE FREQUENCY CONDENSER NOW READY! PICK OUT YOUR STATIONS!! WILL TAKE ANY S.M. DIAL.

We give a handsome Knob & Dial FREE

Supreme Selectivity. This true Straight Line Frequency Condenser will amazingly improve the selectivity of your set. Sturdily built. Electrically and mechanically right-meeting all requirements of low loss design. Mount this real Straight Line Frequency Condenser in your set NOW and experience the joy of quick, certain tuning. Post 6d. set.

.0005 - 8/11
.0003 - 8/6

LOW LOSS SQUARE LAW

This variable Condenser is simply marvellous value for 1/11 cannot be equalled in price or quality.

.0005, 4/11 .0003, 4/9. With vernier 1/- each extra. Post 6d. Set.

SPECIAL DISTRIBUTOR OF ORMOND PRODUCTS.

SQUARE LAW LOW-LOSS, .0005 9/6; .0003, 8/6 (1/6 each less no vernier). FRICTION GEARED, .0005, 15/-; .0003, 14/6; .00025, 18/6. STRAIGHT LINE FREQUENCY FRICTION GEARED, .0005, 20/-; .00035, 19/6. TILAMENT REOSTATS DUAL, 2/8; 6 ohms, or 30 ohms, 2/-; POTENTIOMETER, 400 ohms, 2/6. L.F. SHROUDED, latest model, 17/6.

Send Postcard for Callers and Post Lists.

SUNDRIES: Inland Post, under 10/-, 3d., over 10/-, 6d. extra.

MARCONI PHONE—Auto Series Par. Variometer, 16/-; Steriluz Non Fong V.H., 3/6. Velvac Potentiometer, 9/-; Ideal L.F. Transformers, 30/- (2-7-1, 4-1, 6-1, 8-1). Ideal Junior L.F., 21/-; Valvac, 40-000 ohms, 8/6; H.F. Choke up to 4,000 metres, 10/6; Sterling Baby L.S. 50/-; Sterling Dinkie, 30/-; "Minloss" S.L.V. Condenser, .00025, 21/-; .0005, 24/-; .001, 30/-.

VALVES—Cleartron C.08 or C.15, 12/6; Power 6v, C.25, 15/-; Cosmos 3.P. 18 Red or Green, 12/6; Neutron .06 H.F. or L.F. 12/6. Ditto 2v., 12/6. All Mullard, Ediswan, Osram Marconi, Cosor stocked. Bright D.E. and Power, 8/-; 15-, 15/6; 18/6, 18/6; 24/6, 24/6, 30/-, 22. Mullard F.M.4, 22/6. Do. F.M.3, 18/6. 1 burnt-out valve taken in part exchange for any of above. Usuable valves exchanged.

L.F. TRANSFORMERS—Ferranti A.F.3, 25/-; A.F.4, 17/6; Eureka Concert, 25/-; 2nd Stage, 21/-; Baby at or 2nd, 15/-; Helter, 15/-; Formo shrouded, 10/6; Success (Black), 21/-; Royal, 20/-; Ormond newest model, 15/6; Wates' Supra, 10/6; Croix 5-1, 3-1, 4/6; Marconi "Ideal", all stages, 30/- each; C.A.V., 15/-; Pye, 22/6; Gambrell 2 stages, 25/6; Ideal Junior, 20/-; Lissen T3, 12/6; T2, 15/-; T1, 21/-.

ITEMS OF INTEREST—Cosmos Blue Spot, 12/6; Dimic Coils, 10/-; Base 2/6 (usual wavelength). Ferranti Patent .0005, 13/6; Ferranti Patent .0003, 14/6 (new S.L.F. variatic). Amplifier Frame Aerials, 70/-; Seamark Condense 19/6.

Recognised West-End Distributor of the Manufactures of Edison Bell, Jackson's (J.B.), Polar, Igranite, Peerless, Eureka, Magnum, Burndept, Lotus, Dubliner, Marconi, Dorwood, Sterling, Success, E.B.H., McMichael, Lissen, Woodhall, Utility, R.I., Bowyer-Lowe, A.J.S., Gambrell, Formo, Brunet, Ormonde, Newey, P. & M., etc.

Goods below sent by Post if over 5/- value with 9d. for Postage.

ACCUMULATORS—Ignition capacity. 2 v. 40 amp., 7/11; 2 v. 60 amp., 9/6; 2 v. 80 amp., 12/6; 2 v. 100 amp., 15/11; 4 v. 40 amp., 15/6; 4 v. 60 amp., 18/11; 6 v. 60 amp., 27/6; 6 v. 80 amp., 35/11. **SPECIAL CHEAP LINE**—4 v. 40 amp., 13/11; 4 v. 60 amp., 17/11; 6 v. 60 amp., 25/11. **EBONITE PANELS**, 3/8—For crystal sets, 6x6, 1/-; 7x5, 1/2; 8x6, 1/6; 9x6, 1/9. **EBONITE CUT TO SIZE**—While you wait, or posted. Best "Grade A" 3/16 at 1d. in. at 3d. sq. in. Special Price Large Sizes. **CRYSTAL SETS**—Neutron, 1/-; Midite, 8d.; Shaw's genuine Heritite, 8d., 1/-; **AERIAL EQUIPMENT**—Insulated Rubber Stranded Lead-in, per 10 yds., 1/8. Lead-in Tubes, 8d., 10d., 1/-; Twin Flex, Maroon, 12 yds., 1/4; Do. Red and Black, 12 yds., 1/6. Miniature twin silk, 12 yds., 1/-; Heavy Stranded Lead-in, 6 yds., 2/-; Copper Indoor, 49 strand aerial, 100 ft., 1/6, heavy, 2/8. Insulated hooks, 6 for 6d. Copper Earth Tubes, Climax Pattern, 2/11. **BATTERY BOXES** 6 v. Metal take 14 batteries, 3/9. Lanthernette ditto, 2/11. Both fitted clips. Battery Testers, 4s. Bulbtype Bulbs, 3d. **SUNDRIES**—Adhesive Tape, 4d., 8 drills, 1/8; 5 spanners, 6d. Taps 0 2, 4, 6, BA, 1/11. Screwdrivers, 3d. Breast drills, 0-1 chuck, 8/11. Screw Winder Plugs 3d. pair. Extra quality, 4d. and 6d. pr. Valve windows nickel, 6d. and 8d. Basket coil holders, 10d., 1/-, 6 ft. phone cords, 1/-, 1/3, 1/6. Loud Speaker Cords, 1/6, 1/11. Empire Tape, 12 yds., 6d.

FIXED CONDENSERS—Dublier .0001, 2, 3, 4, 5, each 2/6. .001, 2, 3, 4, 5, 6, each 3/-. Grid Leak, 2/6. Edison Bell, .001, .0001, 2, 3, 4, 5, 1/-; .002, 3, 4, 5, 6, 2/6. .0003 and grid leak 2/-. McMichael with clips, .0001 to .0005, 2/8 each; .001 to .006, 3/- each. Watmel, .0003 and grid leak, 2/6.

LISSENOLA LOUD-SPEAKER UNIT, 13/6. Plated paper reeds, etc., all stocked.

LISSEN Coils, 50x, 6/-; 60x, 6/4; 75x, 6/4; 250x, 9/9 for super selective and neotrodyne circuits. All Lissen parts stocked.

VARIABLE CONDENSERS—Polar Standard, 10/8. Junior, 5/8 each. Bowyer-Lowe Popular, 10/6. Igranite, 24/-, 21/-; Collinson's Low Loss, 21/-, 20/-; Utility, 6/6, 10/8. Vernier 2/8 extra. Utility Low Loss, stocked .0003 and .0005. J.B. (Jackson Bros.), Square Law, .001, 9/6; .0005, 8/-; .0003, 7/-; with vernier, 4/- each extra. Geared, .0005, 15/-; .0003, 13/-; Low Loss, 10/6, 9/-.

EDISON BELL Plugs and Jacks: Jacks, 8/0, 1/8; 8.C., 2/8; D.C. 2/8; S.F., 2/6; D.F., 2/4; 1 pr. Plugs, 2/8.

PERMANENT DETECTORS—R.I., 6/-; One-hole fixing, 7/6; Liberty Fixing, 3/6. Brownie, 3/-.

MAGNUM SCREENED COILS—For Magic Five, 43 ss. set.

APERIODIC H.P.T. 300/600, 350/1200, 1100/3000, 10/- each. West End depot for "MAGNUM" (Burne Jones).

"WONDER AERIAL"—49 strands special phosphor bronze alloy, 110 ft., 3/3.

VARIABLE GRID LEAKS—Lissen, Watmel, 2/6; Bretwood, 3/-; Lissen Anode, 2/6; Watmel, 3/6; Bretwood 3/-.

MOUNTED COILS—STAR—25, 1/3; 35, 1/6; 50, 1/9; 75, 2/-; 100, 2/3; 150, 2/6; 200, 2/9; 250, 3/-; 300, 3/6. GRAM (Patent 200233), air-spaced mounted, 25, 1/6; 35, 1/6; 50, 1/9; 75, 1/11; 100, 2/3; 150, 2/6; 200, 2/11; 250, 3/3; 300, 3/6; 400, 3/8. (Star are extra small and highly recommended.)

"ESSANCO" MOUNTED COILS—Made under Burndept License, Patent No. 108248. No. 25, 35, 50, each 21/-; 75, 2/6; 100, 2/9; 150, 3/-; 200, 250, 300, each 4/-.

IGRANIC-PACENT, Potentiometer, 2/6; 6 or 30 ohms Res., 2/8.

VALVE HOLDERS—BENAMIN, 2/9; Lotus, 2/3; with terminals, 2/8. Sterling Non-Fong, 4/3; Burndept, 5/-; Magnum, 5/-; 2/8; Bowyer-Lowe, 3/-; Ashul, 1/3; H.T.C., 1/6; 1/9; Aeromonic, 1/3; Bretwood, 1/9.

LOUD SPEAKERS—All makes Amplions, all models. Brown's latest, 30/-, 60/-, 120/-, N. and K. solid mahogany, dome centre, 24. Brandes Table Talker, 30/-; Sterling Mellow-vox, 48/-; Telefunken Model, usually 35/-, few only at 18/11.

"ULTRA"—This wonderful Loud-Speaker still holds its own, 27/6. Your old speaker taken part exchange for other goods.

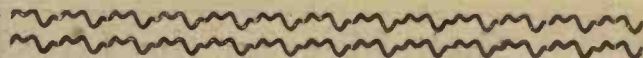

On Guard!

There is no leakage with a "Lotus" Buoyancy Valve Holder on guard. Immediate and lasting connection made when valve pins enter valve sockets. The leg socket expands and automatically locks.

Absorbs shock, protects the valves and eliminates all microphonic noises.

LOTUS VALVE HOLDER



Made from best bakelite moulding with springs of nickel silver and phosphor bronze valve sockets.

Garnett, Whiteley & Co., Ltd., Lotus Works, Broadgreen Rd., Liverpool. Makers of the famous "Lotus" Vernier Coil Holder.

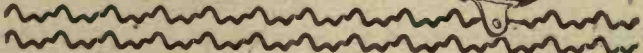

START RIGHT by Building Your Set on a—

TROLITE PANEL DE LUXE

EASILY WORKED—use acetone as adhesive, thus making a strong and neat joint without screws. EFFICIENT & ELEGANT



Supplied Ex Stock Thickness 3/8" 1/4"

4 Finishes: Polished Black Polished Mahogany Polished Walnut Wavy Etched Black

A most attractive panel finish which does not show scratches or finger marks

PRICES	Polished Black ...	3" 1d.	1" 3d.	Sq. inch
	Mahogany, Walnut & Wavy	3" 3d.	1" 1d.	

IF YOUR LOCAL DEALER IS OUT OF STOCK, PLEASE INFORM US HIS NAME AND ADDRESS AT ONCE

F. A. HUGHES & CO., LIMITED 204-6, GT. PORTLAND STREET - - LONDON, W.1 Telephone; MUSEUM 8630-1-2.

K. RAYMOND, 27 & 28a, LISLE ST., Leicester Sq., W.C.2.

OPEN: 9 to 8 Daily, 9 to 9 Saturdays, 11 to 1 Sundays. Phone: Gerrard 4637. Back of Daly's Theatre. Nearest Tube, Leicester Square.

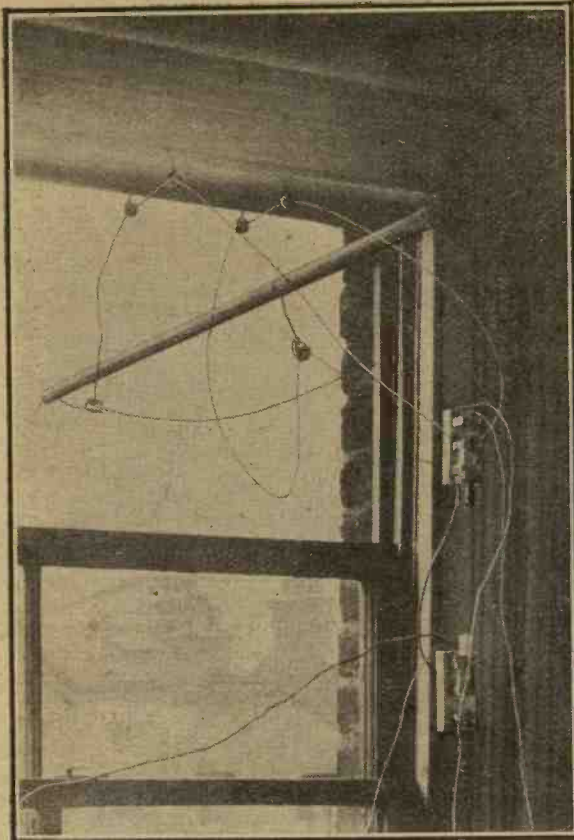

SOME HINTS FOR THE SHORT-WAVE BEGINNER

By GEORGE T. KELSEY

Are you interested in short-wave reception? This article contains a full description of an ingenious aerial arrangement, together with some helpful hints and tips for the short-wave beginner.

waves, several different arrangements are possible.

First, AB can be used as an aerial while CD can be made to serve as a counterpoise. With this arrangement, and using two valves, the writer has received many distant stations including Brazilian 5AB.

A Useful Change-Over

The length AB can be used alone as the aerial for another experiment, employing a direct earth connection instead of the counterpoise, and this arrangement has proved quite effective when receiving distant stations. The use of the "T" aerial for short waves is particularly interesting, and by shorting the two lead-in wires this is possible, a direct earth connection being used in conjunction.

Switching Arrangements

By employing two double-pole double-throw switches it is an easy matter to employ any one of these arrangements with very little trouble, the connections being shown in Fig 2. The wires W, X, Y and Z, represent four leads for making connections to the receiver. With the switch arm of the top switch in the position 2, and that on the lower switch in position

1, then Y can be connected to the aerial terminal of the ordinary broadcast receiver, Z to the earth terminal, and the "T" aerial, with direct earth, will then be available.

It is important when constructing the aerial to make the lengths from A to B and from C to D exactly the same, otherwise a perfect "T" aerial will not be obtained when the top switch arm is in position 2.

Aerial and Counterpoise

To use the split arrangement as an aerial and counterpoise, the arm on the top switch should be placed in position 1. The two leads W and X are now ready for connecting to the receiver or coupling coil as the case may be. The lower switch in this instance is out of circuit so need not be touched. Regarding which half to use for the aerial, it matters little, and here again is an opportunity for experimenting. The two leads W and X might even be changed over when a signal is being received to notice whether an improvement in strength results.

Employing a Direct Earth

To try the effect of one half of the arrangement in conjunction with a direct earth is a simple matter. It is only necessary for the lead W or X, according to which is being used for the counterpoise, to be replaced by the lead Z, the arm of the lower switch being in position 1.

THERE can be no doubt that the work of the amateur transmitter on short wavelengths has done much to annihilate distance.

Only those who have actually listened will know the great thrill accompanying the reception of an amateur station whose call-sign denotes that he is transmitting in some distant land. "It certainly does sound exciting, but how can I listen to these stations?" you will ask. Well, first, it is necessary to acquire a short-wave receiver, and having done that to learn how and when to listen.

Scope for Experiment

An ordinary broadcast aerial can be coupled to the short-wave receiver, but much scope for ingenuity is provided by experimenting with various aerial systems.

In the article to follow, I propose to discuss, amongst other things, a very satisfactory aerial arrangement which is in use at my own home.

An Experimental Aerial

The ideal aerial would seem to be one which, although capable of being used as a broadcast aerial, will lend itself to experimental work. Such an aerial I have had in use for some time, and it is constructed on the lines shown in Fig. 1. The aerial consists of two equal lengths of 7-22's wire AB and CD, which can be shorted for broadcast reception, thus forming a "T" aerial. For the short

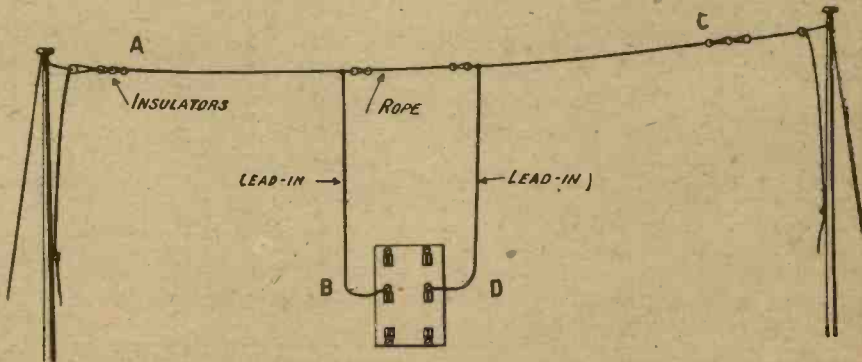

Fig. 1.—It is important when constructing the aerial to make the lengths AB and CD the same.

Some Hints for the Short-Wave Beginner—continued

Precautions Against Lightning

The prevalence of atmospheric disturbances during the summer months calls very definitely for some safety measure, and by placing both the switch arms in position 2 each half of the aerial is earthed.

Just one further suggestion before leaving the aerial subject. Try the simultaneous reception of two stations, say one on the broadcast band and one on short waves, by using the two suspended wires, i.e., AB and CD, as

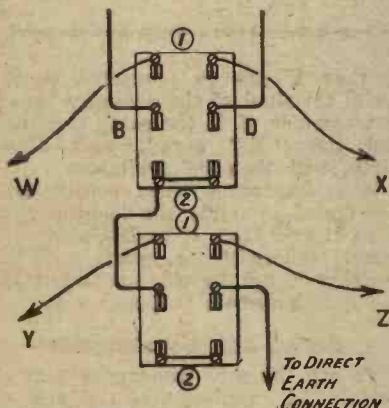
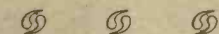

Fig. 2.—The switch arms have been omitted from this diagram in order to make the connections quite clear.

two aerials, connecting one to each receiver, and using a direct earth in each case. The aerial coil in the broadcast receiver will, of course, require to be considerably larger than was used previously in conjunction with the "T" aerial.

Methods of Coupling

Perhaps a few words regarding loose



The pole shown in the heading photograph may be seen in this view projecting from the top left-hand corner of the window.

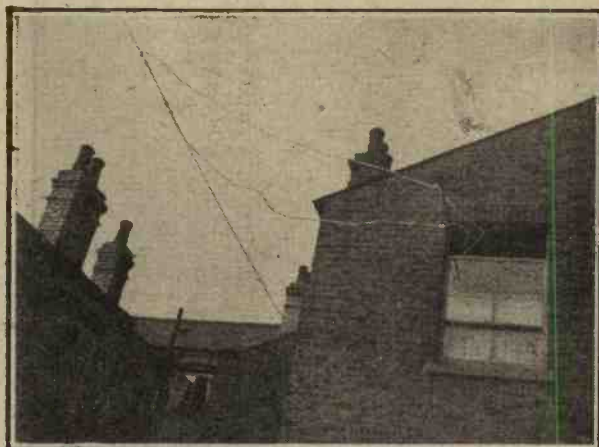
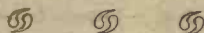

aerial coupling will be of interest to readers. In one of the photographs accompanying this article the coupling unit used by the writer is shown. It consists of a variable condenser of .001 capacity mounted on a small ebonite panel, together with three terminals. The panel is mounted on the left of the picture. The coil on one side of this small box is the actual coupling coil, and it consists of five turns of 16-gauge tinned copper wire. This is coupled to the grid coil of the receiver, which employs Reinartz reaction.

Degree of Coupling

The distance between the coupling coil and the grid coil is not critical in operation, but if the coupling coil is brought too close it may stop the receiver oscillating.

It is often found that at one part of the tuning condenser on the short-wave set the receiver will absolutely refuse to oscillate for no apparent reason. This small range over which oscillation will not take place may be due to the set being tuned to the natural frequency of the aerial.

Curing the Trouble

To overcome this "dead" spot, the variable condenser on the coupling unit comes into service. It should be connected in series with the aerial; that is, between the aerial lead-in and the coil, and by varying the capacity of this condenser the receiver should oscillate in the apparently "dead" spot.

A Note About Reaction

A complete absence of the too-familiar "plop" when the receiver is brought into an oscillating condition is essential if short-wave telephony is to be received. If a "plop" is present, and adjustment of the filament and H.T. voltages fails to bring about a cure, try altering the value of the grid-leak.

It may be found that a fairly high resistance leak is required to cure the "plop," and in my own receiver one having a resistance of four megohms is employed.

When to Listen

There are quite a number of telephony stations to be heard on the 45-metre band, and on Sunday evening between the hours of 6 and 8 many stations can be logged.

Regarding the times to listen for distant C.W. stations, Brazilians may be heard when conditions are good in the evening, and the "BZ" mentioned previously was heard at 10.10 p.m. B.S.T. The American "Hams," whose intermediate letter is "U," can usually be heard under favourable conditions after midnight.

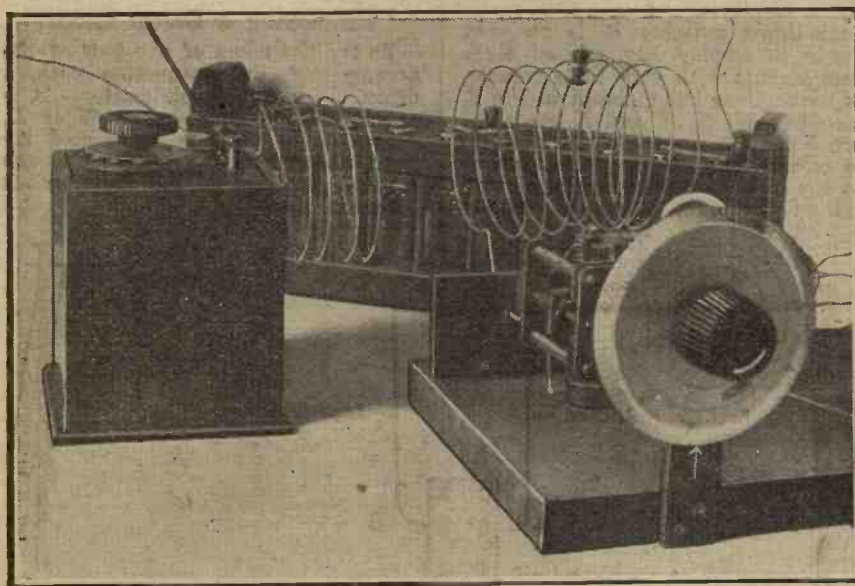

If the coupling coil is brought too close to the grid coil it may stop the receiver oscillating.

TEMPRYTES

(REGD. TRADE MARK.)

The Perfect Control for all
Valve Filaments

Manufactured in values
to suit all valves. From
3 to 55 ohms.

2/6
each.

Holder Mountings for
Temprytes - 1/6 each.

Full particulars on application.

CYLDON

(Pronounced Sil-don)

Grounded Rotor Condensers

The absolute pinnacle of Condenser Perfection.

Square Law.		Straight Line Frequency.	
'001 Mfds.	21/- each	'0005 Mfds.	15/6 each
'0005 "	17/6 "	'00035 "	15/- "
'0003 "	16/6 "	'00025 "	14/6 "
'00025 "	16/- "		
'0002 "	15/6 "		
'0005 Dual	27/6 "		
'0003 "	25/- "		

With 4" Knob Dial. Large 4" Knob Dial, as supplied with Square Law Condensers - 2/- "

The Dual Condenser listed here is as used in the "ELSTREE SIX."

ALL POST FREE BY RETURN ON RECEIPT OF REMITTANCE.

FROM THE MANUFACTURERS: **SYDNEY S. BIRD & SONS,**
Cyldon Works, Sarnesfield Road, Enfield Town,
MIDDLESEX.
Phone: ENFIELD 672.

CAXTON 4-VALVE CABINET

Made for Sets "All Concert Receiver,"
"Fieldless Coil Three Valve Set."
"Any Valve Low Frequency Amplifier."

Special Cabinets made to customer's measurements.
Prices Quoted.

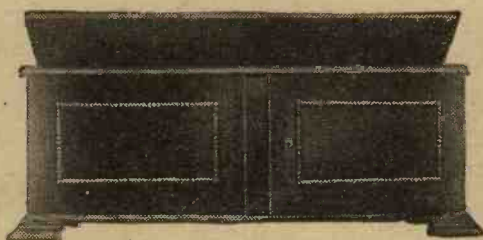

Cash with Order. Fumed Oak	...	£1 5 0
Dark or Jacobean Oak	...	£1 10 0
Real Mahogany	...	£1 14 0

Detachable 7" deep Base Board to mount 16" by 8" panel to slide out of Cabinet front.
The two beaded front doors as illustrated, placed 2 ins. in front of the enclosed panel at 10/- extra.

Ebonite or Radion Panels Supplied and perfectly Fitted at low extra cost.

All Polished with the new enamel that gives a glass hard surface that cannot be soiled or scratched. SENT FREE.—Catalogue of standard Wireless Cabinets in various sizes and woods.

Packed and delivered free in U.K.

No. C2

CAXTON WOOD TURNERY CO., Market Harborough

Dual Condensers for the ELSTREE SIX

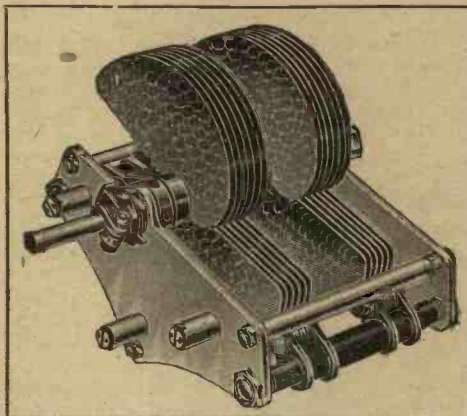

IGRANIC Low-Loss Dual Variable Condensers (square law type) are similar in design to the Standard Igranic Variable Condensers which have been used with such outstanding success in many Radio Press Receivers.

Igranic Variable Condensers have extremely low electrical losses, accurate square law characteristics, combined ball and friction thrust bearings, positive connection to moving plates, accurate rated capacities with extremely small minimum.

Their mechanical construction and finish are of the highest possible standard.

The two halves of the Dual Type are accurately matched.

PRICES:—

'0003 mfd. (each section)	22/6
'0005 mfd. (" ")	27/-
Igranic 4" Combined Knob and Dial	..	2/6
Igranic Indigraph Vernier Knob and Dial	..	7/6

A GOOD CIRCUIT IS WORTHY OF GOOD COMPONENTS — USE IGRANIC CONDENSERS.

Write for List No. J62.

Exclusive

Patent

Manufacturing

Radio

Licences of

Essentials



149, Queen Victoria St., London.

Works: BEDFORD.

Branches: BIRMINGHAM BRISTOL CARDIFF GLASGOW LEEDS
MANCHESTER NEWCASTLE

IMPROVE YOUR REACTION CONTROL!

By L. H. THOMAS (6QB).

Reaction, if properly controlled, forms an invaluable asset to a receiver; if improperly handled it is no more than a nuisance.

ONE hardly ever sees a valve receiver nowadays which does not make use of either "magnetic" or "capacity" reaction in some form, yet probably there is no

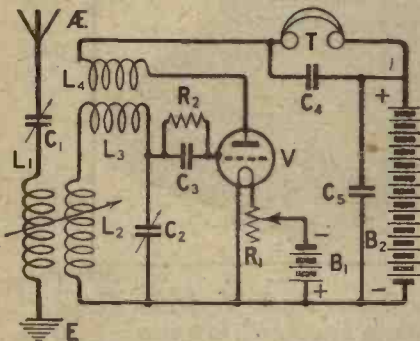

Fig. 1.—The circuit shown employs a "split-secondary" arrangement.

property of the three-electrode valve which is abused (in both senses!) to such a great extent. There seems to be an idea abroad that "reaction" is a kind friend which will compensate for all losses in the most inefficient of sets, and the writer has even met a so-called enthusiast who has expressed the opinion that the "low-loss idea is

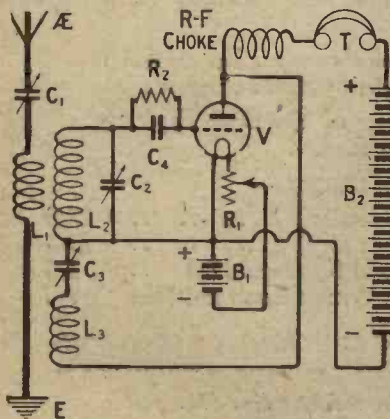

Fig. 2.—The reaction condenser C3 is placed so that one side may be at earth potential.

all bunkum, for if you use reaction, inductances can have as many losses as you like, and it won't make any difference!"

Compensating the Losses

The fact of the matter is that by using reaction in some form we can

introduce negative "resistance" into the circuit, which will to some extent compensate for losses caused by badly-designed coils, etc.

A few years ago little thought was given to the use of any other form of reaction than the "swinging-coil" type, which, incidentally, is still a very widely-used system. A disadvantage of this method of controlling oscillation is not that a fine control is impossible—for with modern slow-motion coilholders quite a small movement of the coils relative to one another is obtainable with the greatest of ease—but that the movement of the reaction

A Way Out of the Difficulty

One way of "getting round" this difficulty is to use a split-secondary type of receiver, in which the aerial and earth are connected to one tuned circuit (corresponding to the ordinary primary coil), and the secondary coil is in two sections, one of which is coupled to the primary, the other being arranged at right-angles to this, and coupled to the reaction coil. The coupling of the reaction coil to this portion of the secondary will then have little effect upon the tuning of the aerial circuit and its part of the



Reaction may often be controlled by means of a small neutralising condenser.

coil away from the secondary coil or A.T.I. causes a variation in the tuning of the latter circuit.

A Question of Practice

In the direct-coupled type of receiver, if we tune in to a station with a particular setting of the reaction coil and then increase the coupling between the reaction coil and the A.T.I., we shall have to alter the setting of the A.T.C. in order to pick the station up again. The same applies in the case of an inductively-coupled receiver, although, perhaps, to a lesser extent.

Until one has become used to operating the coilholder and the A.T.C., not alternately, but simultaneously, it is difficult to tune in telephony to the best advantage, and also one is extremely liable to oscillate and cause serious interference with neighbouring listeners.

secondary. A receiver built on these lines was described by the writer in *Wireless Weekly* for March 17, 1926, and the circuit diagram is shown in Fig. 1.

The Popular "Reinartz"

A rather easier method of controlling reaction, more or less independently of the tuning of the secondary and primary circuits, is to use one of the various forms of capacity reaction, most of which have little effect upon the tuning of the other circuits. Fig. 2 shows one of the best forms of "Reinartz" reaction, which is very easily controlled. Here a high-frequency choke is inserted in the anode circuit of the detector, and no by-pass condenser is usually connected across the telephones.

Thus there is no path provided for H.F. currents in the usual manner via the H.T. battery to earth. A path of variable impedance is provided through the condenser C₃, and this is

Improve Your Reaction Control!—continued

used to control reaction. It will be seen that this is really produced by the coupling of the coils L_2 and L_3 , but is controlled by the condenser C_3 .

"Throttle" Control

A form of capacity-controlled reaction is easily obtainable on an ordi-

coil and the telephones, as shown in Fig. 4, and to connect the variable condenser again from the end of the reaction coil to the L.T. +. Both these methods of controlling reaction may probably be brought into use in your own set within a quarter of an

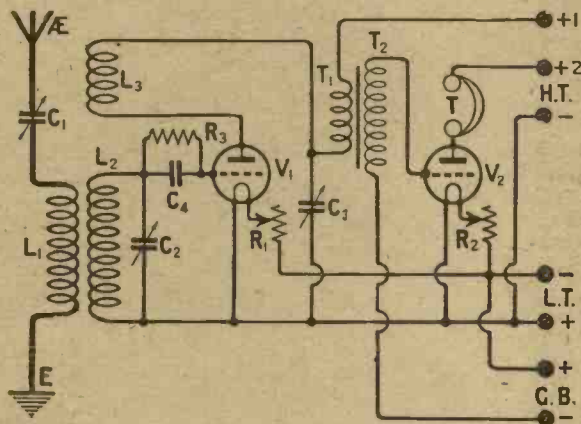

Fig. 3.—A fine control may be obtained by means of a variable condenser connected across the transformer primary and the H.T. battery.

nary "swinging-coil" receiver as follows:—If a low-frequency amplifier is in use after the detector, simply substitute a variable condenser of about .0003 capacity for the fixed by-pass condenser already across the transformer primary, or, better still, connect it across the primary and the H.T. battery, as shown in Fig. 3. This will enable a very fine control of oscillation to be obtained, and one which has only a negligible effect upon the tuning of the aerial circuit.

Only a Slight Alteration

If a single valve only is used, however, it will probably not be sufficient to insert a variable condenser across the telephones, since the capacity of

hour or so, and the astonishing increase in the ease of operation will certainly make it worth while to add these refinements.

An Unusual Method

An unusual, but at the same time very efficient, means of controlling the oscillation of a set is to use a direct-coupled or auto-coupled aerial circuit, with a variable condenser in series with the aerial, and another across the A.T.I. (in parallel). The parallel condenser is used for tuning, and it will be found that with the correct coupling of the reaction coil to the A.T.I., the set can be made to stop oscillating

On the Short Waves

As is well known, for short-wave work the aerial is often coupled to the A.T.I. by a small condenser, and the larger the condenser is made, within reasonable limits, the more efficient is the performance of the receiver.

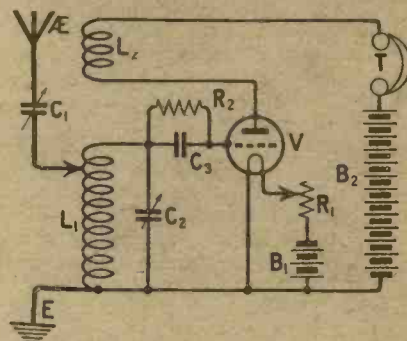

Fig. 5.—Reaction may be controlled here by increasing the amount of capacity in series with the aerial.

I have found that if the aerial series condenser is fairly small, say of .0002 capacity, this method is excellent for controlling reaction on short waves.

A Helpful Refinement

Apropos Reinartz reaction, too often it is found that objectionable noises are heard when the reaction condenser dial is rotated. The writer has found these in most cases to be due to minute leaks caused by an accumulation of dust on the plates of the condenser, which is often across the L.F. transformer primary (or 'phones) and H.T. battery. It is therefore not to be

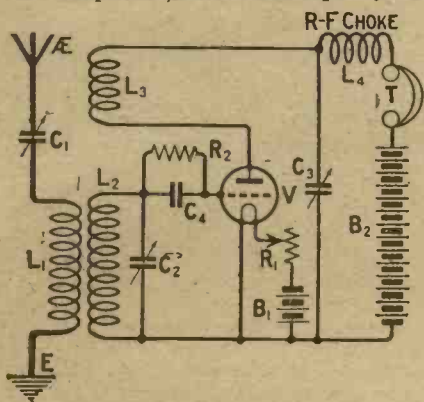
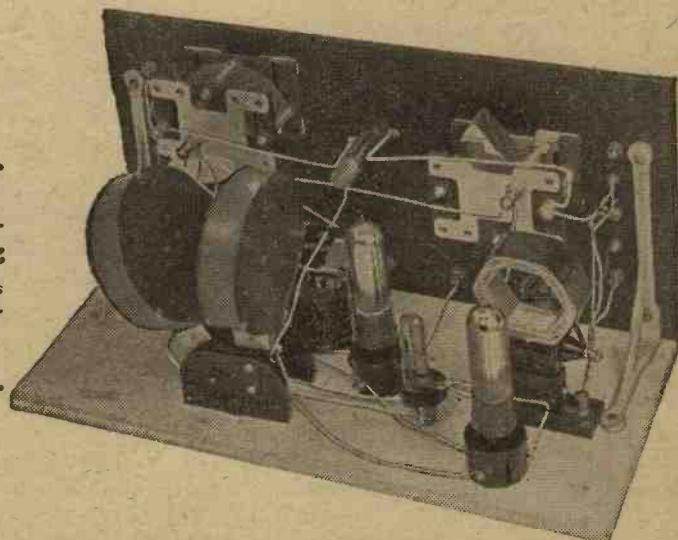

Fig. 4.—Improved results may be obtained by inserting a radio-frequency choke in the position shown.

the 'phone cords, and the capacity to earth via the wearer of the 'phones, will probably by-pass quite enough H.F. current to maintain the receiver in an oscillating state. The obvious remedy is to insert a high-frequency choke between the end of the reaction

by increasing the amount of series condenser in circuit. The effect of doing this is to increase the damping effect of the aerial upon the grid circuit, and thus to vary the degree of oscillation.



Unless a good coil-holder is used, "swinging-coil" reaction control is apt to be troublesome.

wondered at if the set is noisy. The simplest remedy is to connect a large fixed condenser in series with the variable, which will have the effect of keeping the high potential off the plates of the latter.

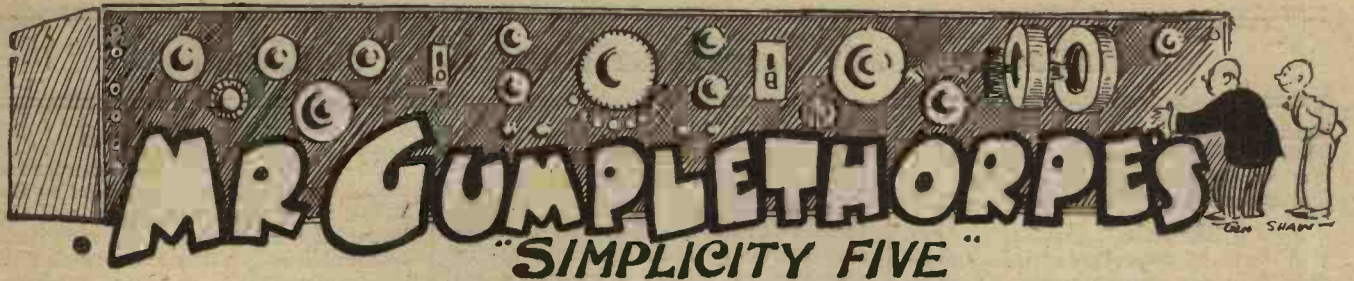

MY friend Mr. Gumplethorpe is feeling very perplexed just now. Hardly had the winter departed when his eye was caught by a poster which ordered him peremptorily to take his holiday early and get the best of the weather. Mr. Gumplethorpe, who is a law-abiding soul, is the kind of person who always obeys instructions of this kind. If he sees a sign which says keep to the right he keeps to the right, even if it means cannoning violently into heaps of other people who are failing to do as they are told.

One day, I remember, whilst he was in London he observed written upon a neat little board, "Wait Here For The Highgate Trams." Mr. Gumplethorpe did not in the least desire to go to Highgate, but he felt impelled to wait just the same.

Take Your Holidays Early

Since he is that kind of person, you may imagine that he at once decided to take his holiday in May and get the best of the weather. Lightheartedly he departed for Bogmouth, only to find that there was not any weather worth speaking about, or perhaps I should say that there were samples of all kinds of weather, which everybody was speaking about quite a lot. Chilled to the marrow and without a dry stitch in his wardrobe, he decided at the end of a couple of days that he had possibly taken the advice rather too literally.

The Month of Roses

He returned home, resolving to have a glorious time in June, which other posters assured him was the best of all months. On the first of that month he departed from SkeggsPOOL, where he stuck it for three days. His third attempt resulted in a July visit to Scarbourn, and yet another wash-out—I am using the last word in the literal sense. He tells me that if his August endeavour is unsuccessful he intends to take his real holiday in Spitzbergen at Christmas time, for, as he says, you are pretty certain of the weather there at that season.

Good Intentions, Poor Realisations

All this dashing about the country has, of course, interfered seriously with his practical devotion to wireless. He intended to build a three-valver at Bogmouth, but his hand was shaking so when he tried to use a scribe that all his straight lines looked like the conventional signs for resistances. In

June he had made every preparation for building at SkeggsPOOL a fifteen-valve super, but found it quite impossible to eliminate the damping. In July he decided upon a less ambitious programme at Scarbourn, taking away with him the materials for a simple crystal receiver; but as the cabinet and everything else warped, he reluctantly decided to postpone construction until his return home.



He keeps to the right

The Worried Professor

When I dropped in to see him a week or two ago I found him much worried about his next receiving set, for he was quite unable to decide what to build. "Why not the Five Fifteen?" I asked. "If you would kindly pay attention," said Mr. Gumplethorpe, "you would find that I am talking about wireless sets, and not about trains." I explained that the Five Fifteen was a wireless set, though for the life of me I could not



Won't that look beautiful

remember the reason why it was so christened. After some discussion, we came to the conclusion that it must be a receiver specially designed for bringing in the Children's Corner. On thinking it over, I am still not quite sure that this is correct.

That Single Control

Mr. Gumplethorpe hesitated for a long time about making up the Five Fifteen, but after much thought he resolved to produce a design entirely of his own. The main feature was to be that it should possess but a single control. We christened the receiver provisionally the "Simplicity Five,"

having decided that to call it the "Five One" might savour of plagiarism. Having, fortunately, a 24 x 8 cabinet, complete with panel, at hand, Mr. Gumplethorpe drilled a single three-eighth inch hole right in the middle of the virgin expanse of ebonite, and said with a smile, "Now won't that look beautiful when it is finished."

Selectivity of the Best?

Two or three days later he told me that the "Simplicity Five" was finished, and begged me to come in at once to sample it. I went. There seemed to be something not quite right about the "Simplicity Five." It appeared, for example, to be slightly lacking in selectivity, since he had difficulty in separating Radio-Paris from 2LO. When he was making his original designs Mr. Gumplethorpe had assured me that slight movements of his single knob would enable him to bring in dozens and dozens of stations.

His expectations were fully justified; the only drawback was that it brought them in all at once. You know what happens when you have called in to see a set made by somebody else. Ideas for improvements rush by the dozen into what you are conceited enough to call your brain.

Helpful Suggestions

My first suggestion was that the rectifying valve should have a variable grid-leak. Mr. Gumplethorpe thought that this was a good idea, and that possibly a further improvement would result if he fitted similar gadgets to the two H.F. valves. We got to work at once, and put these in in a neat row on the panel. This made things a little better, though there was still a background of Aberdeen when we tuned in Stoke. Mr. Gumplethorpe thought that he might obtain increased selectivity by rather finer filament control than that provided by the fixed resistances that he was using. By skilful planning we found room for a straight row of five rheostats. It was getting rather late then, but we just had time before we parted to add a variable resistance connected across the secondary of the first low-frequency transformer.

Results Show an Improvement

Next day Mr. Gumplethorpe called in to tell me that he was obtaining promising results from the addition of a vernier rheostat to the rectifier

"THE SIMPLICITY FIVE"—continued

valve. I thoroughly approved of this and suggested that he should convert his present single-circuit tuner into a double by adding a two-coil holder. I also told him that I was a great believer in tuning both the aerial and the grid circuit of the first valve. Mr. Gumplethorpe promised to make these little alterations and said that after considerable thought he had decided to tune both the grid and anode circuits of all the high-frequency valves.



... Scrap the original cabinet ...

A Larger Panel

On my next visit we found it necessary to scrap the original cabinet since its panel hardly gave us room for the five variable condensers that were needed in addition to the other gadgets. As we found that all this tuning rendered the receiver somewhat unstable we resolved to neutralise the high-frequency valves and to fit the rectifier with capacity reaction. This meant three more small condensers for which room had to be found. A 36 x 8 panel was promptly ordered and as soon as it arrived we got to work once more.

Vernier Dials Essential

Hardly had we begun to try the set out in its new form when it occurred to me that really fine tuning was prac-



... A 72-inch panel was needed ...

tically impossible with the large condensers fitted. We found that things were very much better when we had provided each with a vernier. As things were becoming unduly crowded Mr. Gumplethorpe despatched an order by wire for a 42-inch panel.

Switches, of Course

This, of course, gave us a much wider field for our activities and we were able to tap the anode coils and to mount selector switch on the

panel. Then I began to wonder whether it would not be a good idea to add a potentiometer and a neat little switch for enabling the gridleak to be connected at will to filament positive or filament negative. Mr. Gumplethorpe heartily approved and said that as the question of switches had been raised he proposed to add a series-parallel arrangement as well as one for giving the tune or standby positions at will. These we rigged up without delay.

Still Growing

We now found that with all five valves in use signal strength from the local station was excessive. It was a simple business to add one of those little lever switches which enable one high-frequency valve to be cut out. A 48-inch panel was ordered and we settled down once more to our task. Except that it seemed to need a grid battery with selector switch, the high-frequency end of the set now seemed pretty good. We therefore turned our attention to the note-magnifying department, pausing first for a little while whilst we provided the rectifier with a variable grid condenser.

Further Complications

Having worked out a very neat switching arrangement for cutting out one of the low-frequency valves at will we next fitted a tone filter, using a number of clip-in condensers and arranging for the raising or the lowering of the pitch by means of a particularly neat ten-stud switch. As Mr. Gumplethorpe possesses both high and low resistance loud-speakers we also devised a switch which would enable a telephone transformer to be brought into circuit when required, and another switch enabled him to use the tone filter or not just as he liked.

The Result!

Ordering a 60-inch panel so as to be on the safe side we enormously improved the selectivity of the set by building in a wave-trap. When we had added switching arrangements to permit different kinds of wave-trap to be used, and had incorporated a neat device by means of which transformer, or resistance-capacity, or choke-capacity coupling could be obtained at will between the first and second note magnifiers, we found that a 72-inch panel was needed if there were to be any more improvements, as it was practically certain that there would be.

Mr. Gumplethorpe rather hankers over "The Five Fifty-Seven" as a name for his latest production, but somehow I think that "The Tragic Five" suits it better.

ANOTHER VALVE HOLDER TIP FROM A READER

SIR,—In the issue of THE WIRELESS CONSTRUCTOR for July you publish a letter from a New Zealand reader, Mr. L. J. Mason, giving a tip for valve mounting. May I be allowed to bring to your notice a somewhat similar method of valve mounting which I

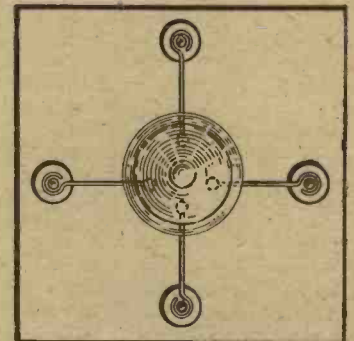

have used and found very satisfactory in practice? This consists in forming small loops at the end of lengths of No. 16 S.W.G. bare copper wire, slipping these loops over the tips of the legs of the valve and soldering them in position. The lengths of wire are then cut to be about an inch long, and loops are formed at the free ends. These latter loops fit on to terminals suitably spaced out on a piece of ebonite.

This arrangement, of course, prevents one from using the valves in ordinary valve-holders, unless the wires are taken off and the legs are scraped

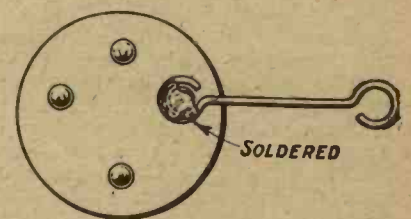

clean of solder. Since I make up all my "valve-holders" in this way now, I do not myself find this any great disadvantage. This method of mounting must be of low self-capacity, since there is nothing but air between the valve legs, and I also find that it provides quite a good anti-microphonic support for the valve, owing to the springiness of the lengths of wire. By arranging all the groups of terminals in exactly the same positions in different "holders," the valves are readily made interchangeable.

Yours faithfully,
A. R. WILSON.

Manchester.



DO YOU KEEP A CRYSTAL CHECK?

.....
An interesting adjunct which should be made up by anyone who has a multi-valve set.

THE uses of a crystal set are not confined to simple listening to the programmes from the local station. There are cases in which such a set is of assistance to the multi-valve enthusiast, and the receiver described in this article is designed to serve not only as a simple crystal set, but also as an adjunct to a valve set.

A Check on Quality

Occasions arise from time to time when the quality of the reception deteriorates, and the results are not as satisfactory as usual. It may be that after investigating all the usual sources of trouble, such as run down H.T., incorrect grid bias, etc., the quality still remains poor.

In such circumstances it is useful to be able to obtain an independent check on the transmission itself, and a crystal set is admirable for this purpose, since the reproduction is as nearly perfect as can be and the expense of upkeep is nil.

Other occasions on which a standby crystal set are useful will readily occur to the reader and need not be further elaborated.

Simple Switching

The present set, therefore, has been constructed with a view to providing a simple reasonably efficient arrangement. A change-over switch is provided to enable the set to be cut in or out at will. With the test set cut out, the aerial and earth are connected

direct to the receiver, while in the other position the aerial system is connected to the crystal set, the 'phones being removed from the ordinary receiver and connected in the crystal circuit.

The Circuit

The actual circuit is shown in Fig. 1. The aerial and earth are connected to the centre-poles of the change-over switch. One side of the switch goes to further terminals, ultimately connected to the receiver, while the other

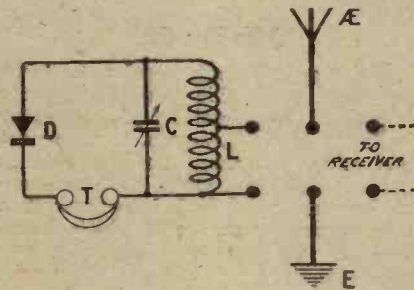

Fig. 1.—The change-over switch connects the aerial and earth either to the set or to the crystal check.

side goes to the tuned circuit. The aerial circuit is only connected across a portion of the coil. This enables the set to be used on a variety of aeri- als with satisfactory results. While the position chosen is not neces-

sarily the optimum tapping, it serves to reduce the effect of different sizes of aerial.

The Components

The construction adopted is of a very simple character, although, nevertheless, quite efficient. The whole has been mounted on a wooden panel, and is only 6½ in. by 4 in. when complete. A dial-o-densifier has been used, so that the depth of the set is only about 1 in.

The components required are:—

- One dial-o-densifier, .0005 (Portable Utilities, Ltd.).
- One permanent crystal-detector (R.I., Ltd.).
- One change-over switch.
- Six terminals.
- One plywood panel, 6½ in. by 4 in.
- ¼ lb. No. 22 d.c.c. wire.
- One length of Glazite wire.
- Packet of Radio Press panel trans- fers.

Mounting the Components

The first stage in making up the set is to drill the holes for the variable condenser, the six terminals, the crystal detector and the change-over switch. The instructions for fixing the dial-o-densifier are given with the component itself, and no difficulty will be experienced on this point.

Mount the change-over switch and crystal detector in the positions shown and finally insert the six terminals.

The two pairs at the top of the set

A Useful Accessory to Any Valve Set

are for the aerial and earth and the connections to the receiver, the bottom two being for the telephones.

The Coil

The coil itself has been home-wound, and consists of a simple hank coil. This may be wound with 22 double cotton-covered wire on a suitable cylindrical object having a diameter of about 2½ in. or 3 in. An ordinary tumbler will serve if of sufficiently large diameter.

Wind on 10 turns and then take a loop out as shown in Fig. 3. This will serve for the tapping to the crystal detector. Continue the winding now for another 25 turns, making 35 in all. This will tune with the .0005 condenser on an average aerial over the whole of the B.B.C. wavelength range.

Wiring Up

The coil is held in position by the wiring, as will be seen. Wire up the set as shown in Fig. 3. The details are of the simplest, the only special point being the coil.

The beginning of the coil is connected to the earth side of the switch and to the spindle of the dial-o-denser. The tapping at 10 turns is then taken to the aerial side of the switch, and the end of the coil is connected to the crystal detector and the flex lead on the dial-o-denser.

Operation

The receiver is very simple to operate. It may be hung on the wall

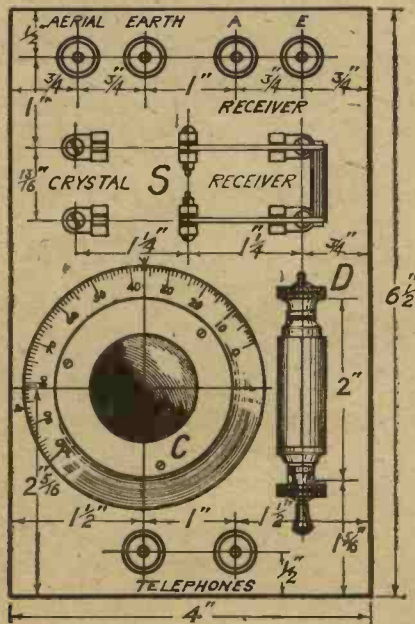
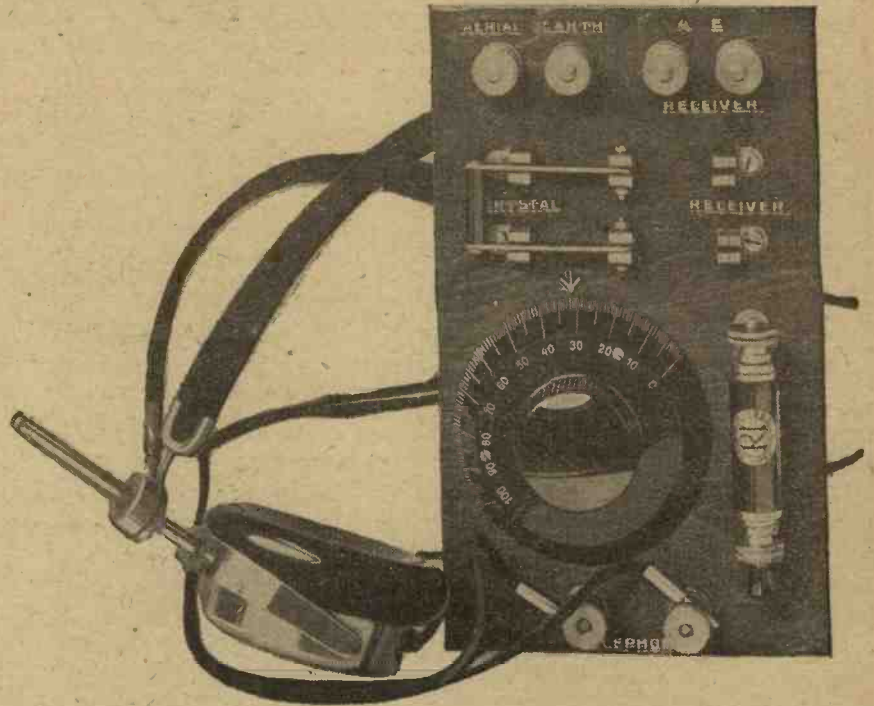

Fig. 2.—The layout of the components may be obtained from this diagram.



The receiver is of very small dimensions.

or placed in any convenient position. The aerial and earth are connected to the top left-hand terminals and two leads then taken from the right-hand terminals to the ordinary receiver.

Place the switch to "receiver," when the receiver may be operated in the usual way.

To obtain a check on the quality, place the switch to "crystal" and connect the 'phones to the terminals provided. On tuning the condenser now the local station will be obtained and the transmission may be accurately gauged.

An Indication

If the quality on the crystal set is satisfactory, this shows that there is a fault on the receiver itself. The usual points may then be looked to in order to trace whether there is any source of distortion in the receiver.

It may be that there is too much reaction on the high-frequency side. This will cause the tuned circuits to be too near the oscillation point, which causes "woolly" quality as if the speaker had a plum in his mouth.

Correct Grid Bias

If this is not the cause of the trouble, the L.F. side may be investigated, and the grid bias on the valve or valves varied slightly to see if the quality is improved by so doing.

Too little grid bias will allow grid current to flow and will give rise to

distortion, but on the other hand too much bias will give an equal amount of distortion.

Suitable Valves

If a loud-speaker is used a power valve is essential on the last stage if

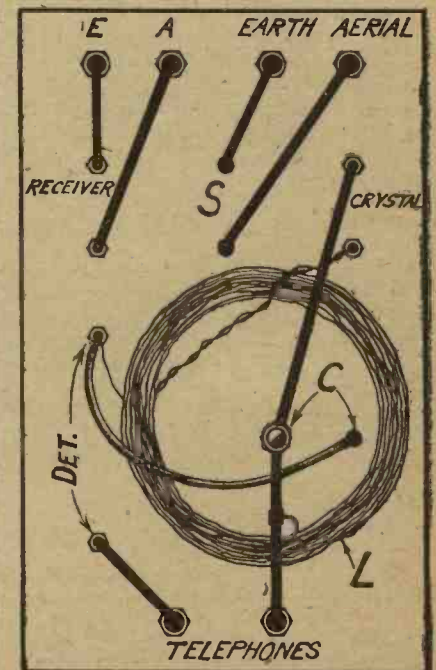

Fig. 3.—The wiring is very simple.

DO YOU KEEP A CRYSTAL CHECK?—*continued*

any volume is to be handled. If an ordinary valve is used the characteristic may not be long enough to provide true reproduction.

A Useful Adjunct

On the other hand, if the quality on the crystal check set is poor then this shows that for some reason or other the transmission is at fault. This, of course, is not often the case, but it does happen at times, and on such occasions the crystal check will save a good deal of trouble in locating the fault.

In Case of Breakdown

It occasionally happens, too, that a breakdown occurs at the local broadcasting station, and the listener is

temporarily in doubt as to whether or not it is his receiver which is at fault. The natural inclination on such occasions is to make all possible adjustments on the receiver to see whether the fault can be put right. Nothing, of course, is achieved by this, and very often a valve receiver will be set into a state of oscillation by such handling, in an endeavour to find the carrier wave from the local station.

This undesirable state of affairs may be avoided if the crystal check is installed. So long as the listener's aerial and earth system is known to be in order, then listening on the crystal set will indicate whether the local station is actually working or not, and much needless trouble and annoyance will be saved.

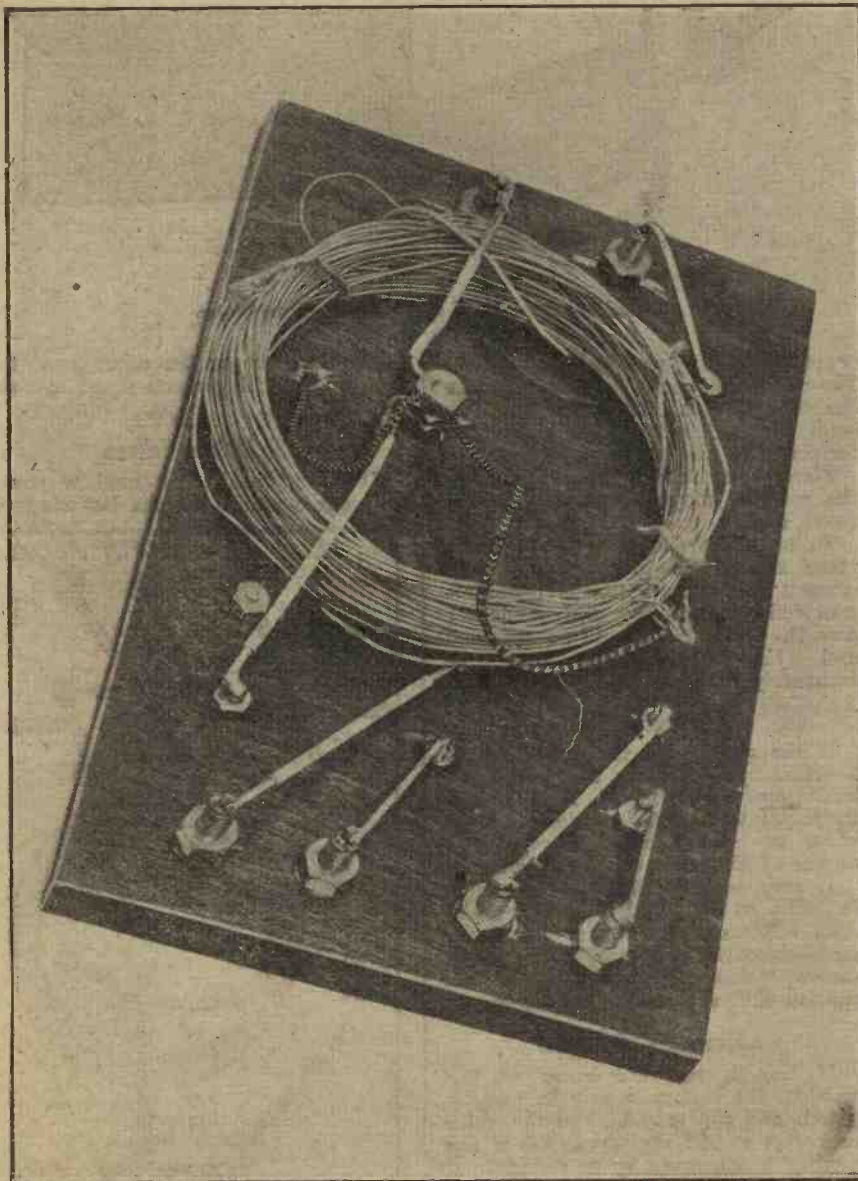

A hand-wound coil is employed in this receiver.

YOUTH AND THE "MIDGET" RECEIVER

SIR,—I feel I must write and tell you of the splendid results I have had with the "Midget One-Valve Receiver" designed by Mr. A. S. Clark (May, 1925, issue of THE WIRELESS CONSTRUCTOR). I have not long made it up but have got over 90 stations, including amateurs. Some of the broadcasting stations are 5XX and 2LO audible and readable on an Amp-lion loud-speaker, 6BM, 2ZY, 5WA, 5NG (obtainable in daylight any day), and Leeds-Bradford. The best of the foreigners is Hamburg, then comes Radio-Toulouse, Brussels, Dortmund, Bremen, Hanover, Rome, Union Radio Madrid, Münster and Munich. Koenigswusterhausen and Hilversum are also clear at times.

My aerial is of the single-wire type, 75 ft. long, with lead-in 15 ft., while the earth consists of five wires spread fan-wise under the aerial about 1 ft. deep. The panel is the same size, but slight alterations have been made in the set while keeping the wiring quite short. The set goes down to the short waves well (125-200 metre band), and many amateurs are heard. I am 15 miles from London, and 15 years old.

Wishing you all prosperity.—Yours sincerely,

J. B. COXALL.

Inglenook.

P.S.—I agree with Mr. Clark that the shorter wiring is better. I have made long-wire sets and tested them against the "Midget," which comes out top every time.

* * *

SIR,—I am writing to tell you how much I appreciate the "Midget One-Valve Receiver" as described by Mr. A. S. Clark in the May, 1925, issue of THE WIRELESS CONSTRUCTOR. So far, using 35 and 75 coils, I have received 6KH faint but just readable, 5NO at good 'phone strength, 2LS clear, 2ZY loud, Dublin at good 'phone strength, and also one German station whose call-sign I could not identify.

Wishing THE WIRELESS CONSTRUCTOR every success.—Yours faithfully,

BRIAN POMEROY.

Harrogate.

P.S.—Although I am only 14 I found no difficulty in constructing this set.

"WIRELESS"
"BOOM" NUMBER
2d. NOW ON SALE 2d.



TALKS TO BEGINNERS

By PERCY W. HARRIS, M.I.R.E.

This is the fifth article of Mr. Harris' interesting series.

V.—MORE ABOUT TUNING.

LAST month we talked about condensers, and I explained how variable condensers are made to interleave their plates so that the capacity, as it is called, can be varied continuously within limits. I mentioned that when we connect the source of electricity to a condenser a certain time is taken to charge it, and the larger the condenser the longer the charging period.

If the condenser is already charged and we connect the two terminals by means of a wire, the state of electrical strain set up in the insulating medium between the plates (constituting the charge) will be released and a momentary electric current will flow between the two condenser terminals. The condenser will not discharge absolutely instantaneously, but a certain definite minute period will elapse before the discharge is completed. The manner of this discharge is highly important if we are to understand the way a wireless receiver works.

Magnetic Effects

If we connect a length of wire to the two terminals of some source of electrical pressure, such as a battery, a dynamo, or a charged condenser, a current will start to flow in the wire. At the same time a magnetic field will begin to form outside the wire. Until this magnetic field is formed the current will not flow steadily, and as a certain time is taken for the building up of this field, the flow of current is not instantaneous when we connect the wire to the two terminals of a condenser.

Furthermore, if we have a wire wound in the form of a coil, the magnetic field surrounding each turn interacts with the magnetic field surrounding every other turn and hinders its growth. For this reason it takes a longer time for the current to be built up in a coil of wire than in the same length of wire pulled out straight. The longer the wire (coiled or straight) the longer the period taken for the current to reach normal. Similarly, if once the current has reached the steady state, the electrical pressure is varied, the magnetic field surrounding the wire takes a certain time to die down or increase further,

and this all tends to hinder any change from taking place.

The Condenser Discharge

Now let us return to the case of our charged condenser, to the terminals of which we have connected a coil of wire. As mentioned already, the condenser is a source of electrical pressure when in a charged state, and this pressure being applied to the wire, tends to create a current in it. The building up of the magnetic field around the wire occupies a certain time, and with a given size of condenser, the discharge takes longer with a long coil than with a short one. Directly the coil is applied to the terminals of the condenser, a current starts to flow, and as the charge in the condenser is reduced, so the current will fall until a point is reached when

the condenser over-runs itself, as it were, and is charged up by the effect of this field in the opposite direction. By the time the field has completely collapsed, therefore, there is a further opposite charge in the condenser which once again will tend to discharge, again setting up a magnetic field and again tending to prolong itself.

The phenomenon may be explained in a few words by saying that the discharge of the condenser is "oscillatory," swinging backwards and forwards till the current gradually comes to rest, much in the same way as a child's swing moves backwards and forwards until it gradually comes to rest.

Infinitesimal Time

To give you some idea of the time occupied in this process I may say

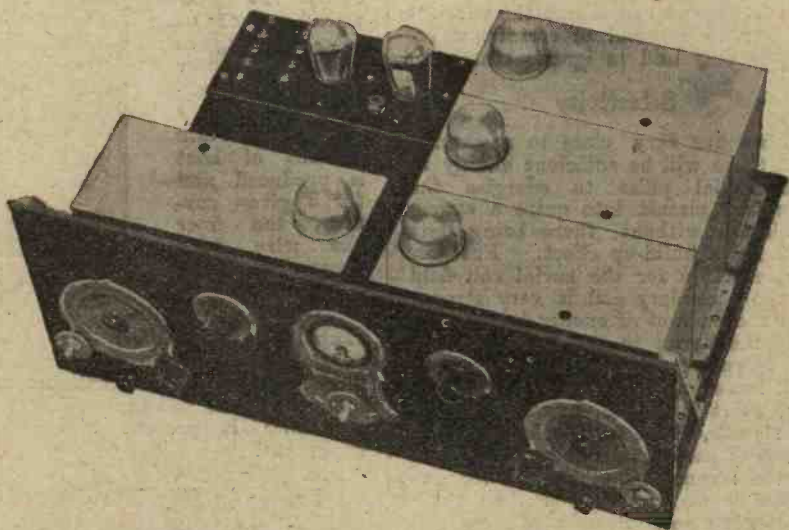

An example of a completely screened American receiver. Even the valves are screened!

the condenser has no further charge in it.

Now remember what we have just said about the magnetic field created around the wire as the current grows. When the point has been reached when there is no further charge in the condenser, there exists around the wire a magnetic field. This field must now die away, but in doing so it tends to make the current persist, and so

that a condenser of the size generally used in wireless receivers for tuning, connected to a coil of some fifty turns of wire wound round a two-inch former, will discharge and charge itself again in the opposite direction at something between half-a-million and a million times a second—or rather at this rate, for the oscillations will not persist for anything approaching a second in such circumstances.

Talks to Beginners—continued

If now we arrange what is called a "circuit" with a variable condenser and a coil of wire connected to it and in such a way that the pulses of electric current set up in the aerial by the oncoming wave act on this circuit, then, if the circuit is in "tune" or "resonance" with the frequency of the incoming wave, each little pulsation will add to the electrical oscillation of the circuit giving a building-up effect.

An Aerial Circuit

The manner of making this connection can take several forms. In one form a small coil of wire is connected in the aerial and the magnetic field set up around the coil acts on a second coil of wire to which the variable condenser is connected. Changes of the magnetic field around the aerial coil act on the second or "secondary" coil as it is often called, causing a series of charges in the condenser which are tuned to complete resonance. It is thus possible to build up by resonance quite a large charge in the variable condenser, but only provided that the value of the condenser capacity and the electrical size of the coil are correctly chosen. A built-up effect is therefore obtained on one wavelength only, wavelengths and pulsations of different frequency producing very little build up or "resonance" effect. This is why we can adjust the wireless receiver to respond to certain wavelengths only and to ignore others.

Selectivity

If we are very close to a station then there will be sufficient energy in each aerial pulse to energise the secondary circuit into quite a strong oscillation without there being any need for a build-up effect. Further, if interaction for the aerial coil field on the secondary coil is very strong, then the amount of energy transferred from the aerial to the secondary circuit in each pulsation will be large.

If, however, we "loosen" the coupling, as it is called, however strong the signals, there will be less transfer of energy each swing, and more chance for the resonance build-up on the one frequency we want rather than those we do not want. Sometimes the aerial is so connected that a part of the secondary coil forms the aerial coil while in very simple and non-selective sets, the whole of the secondary coil is also in the aerial circuit. This is called direct coupling.

Effect of Resistance

We have thus seen how it is possible to arrange a condenser and a coil of wire which can be adjusted to respond to certain frequencies only and not to others. Before we go further now we

must consider the question of damping or resistance. Resistance plays a very important part in wireless in the question of selectivity.

If you try to ride a bicycle the bearings of which have not been oiled you will find it is very stiff going, for there will be friction between the moving and fixed parts in contact with one another. We have in electrical circuits an equivalent of this friction or resistance to movement. Whenever current flows through wire a certain resistance is offered by the wire, varying with the metal and size of the conductor.

An Extreme Case

An extreme case of a very fine wire through which considerable current is forced is evidenced within the bulb of an electric lamp. Here the resistance offered to the flow of the current is such that the wire becomes white hot, and emits the glow which serves us so usefully as light. Whenever an electric current flows in a circuit a certain amount of heat is produced and for a given current, the finer the wire the greater the heat.

In wireless receivers the currents are very, very small, and therefore we can use fine wire in receivers without undue loss in heat, but nevertheless the resistance is present and is very important.

Losses in Wireless Circuits

Resistance enters into our calculations when we consider the oscillatory current flowing in the circuit consisting of a condenser and a coil of wire or "inductance." Once we start energy oscillating in this circuit, it would continue oscillating indefinitely but for the losses of the circuit. These losses take two main forms, loss by resistance in heat and loss by radiation.

The energy lost by radiation is generally expressed in the same terms as that lost through heat. In a wire-

less transmitter we want to radiate considerable energy and so lose it from the circuit, but we do not want to waste energy in merely heating up the wire. To separate the two losses due respectively to radiation and heat, it is usual to refer to the former in terms of "radiation resistance" and the latter in terms of "ohmic resistance."

Radiation Resistance

It is the aim of a designer of a wire-

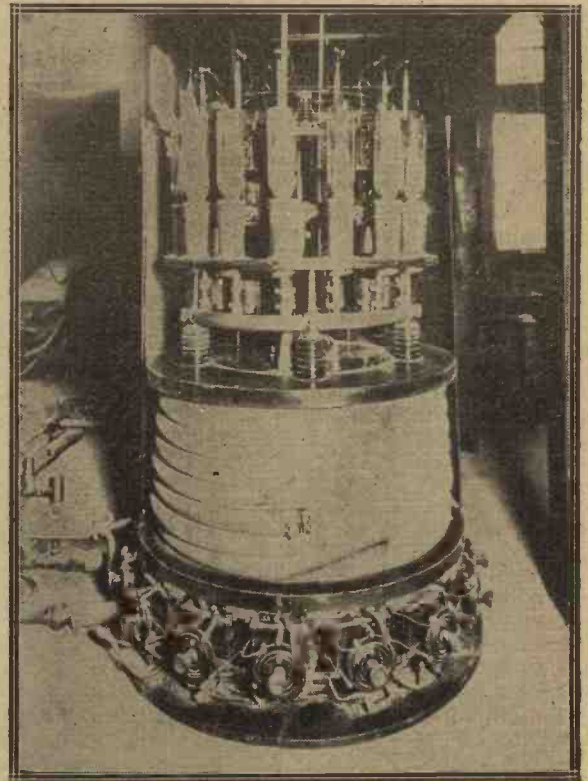

A bank of power amplifying valves used in the Transatlantic Telephony Service.

less transmitter to keep the ohmic resistance as low as possible and to have a good radiation resistance. A wireless transmitter which has no radiation resistance and all ohmic resistance would not broadcast at all, for nothing whatever would be heard from it!

It is usually to our advantage, however, to reduce the ohmic resistance in a tuning circuit as far as possible. For this reason there has been a great vogue of what are called "low-loss coils" or coils wound in such a way and of such material that the ohmic resistance is reduced to a very low figure. Resistance is not invariably bad in a wireless circuit, however, and is used in many cases to produce some useful effects. I will tell you about these in the next instalment of this talk.



A page of information of interest to all constructors.

By H. J. BARTON-CHAPPLE, Wh.Sch., B.Sc. (Hons.), A.C.G.I., D.I.C., A.M.I.E.E.

WHEN testing out a multi-valve set and using general-purpose valves, the best plan is to keep interchanging the valves so that they work in all positions and combinations. It will then most probably be found that some work better in one position than another, due to a particular inherent characteristic, and it is advisable then to mark the valves with the letters L.F., D., or H.F., so that they can be recognised quickly for future occasions.

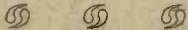

IN order to get that "little bit of extra power" from a receiving set there is often a tendency to turn on the valves so that they glow a little brighter, or alternatively the expedient of using too high a value of anode voltage may be tried. With dull-emitter valves in use this practice should always be avoided, for although the filaments may not be burnt out there is a very grave risk of causing these filaments to lose their emission and necessitating a process of rejuvenation.

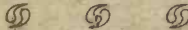

VALVE filaments that are manufactured from a mixture of thoria and tungsten go through a special heat treatment which enables them to give the same emission as ordinary tungsten, but at a lower filament temperature. To restore the emission lost through over-running as mentioned in the previous note, it is necessary to disconnect the high-tension supply and run the valve (or valves) at normal filament voltage.

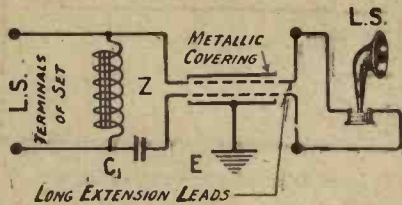
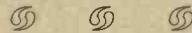

Fig. 1.—An earthed metallic screen round extension leads is helpful if A.C. hum is troublesome.

When this simple process proves ineffective a filament voltage of about three times the normal value should be applied for a few seconds only with the H.T. disconnected. Then

light the valves at a little above their normal voltage with the H.T. still disconnected, and the emission will then be restored in the majority of cases.

This somewhat drastic treatment may result in a burnt-out valve, but since the valve would be useless in any case the experiment merits a trial.



THE provision of terminals in addition to soldering tags on many wireless components now on the market is, no doubt, welcomed by many home constructors who still experience difficulty with soldered joints. When using these terminals make quite sure that any lacquer is removed from the surface in contact with the connecting wire, and then tighten up the terminal nuts with a pair of pliers.

If this is done it will ensure that a sound electrical joint is made, and no difficulties should arise owing to intermittent contacts in the completed receiver which, of course, would militate against efficient signal reception.

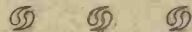

IT often becomes necessary or desirable to remove the loud-speaker or telephones to some position in the house which is remote from the receiving set. When this is effected with the aid of extension leads it is frequently found that if the house is supplied with alternating current for lighting or power purposes an unpleasant humming noise is heard in the telephones or loud-speaker.

This effect can be minimised and often entirely overcome by trying various alternative routes for the run of the leads or by making use of twin cable which is supplied with a metallic sheathing or covering, and earthing this outer casing. If this is used in conjunction with a filter circuit, as shown in Fig. 1, then stability of working and absence of irritating noises can be obtained.

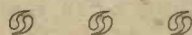

IT is frequently found that when wearing a pair of head 'phones during the hot summer weather the ear-caps and diaphragms become covered with moisture. While this is perhaps unavoidable, unless thoroughly

wiped after use there is a liability of the diaphragms becoming rusty.

When there are any signs of oxidation present steps should be taken immediately to repair the damage. The ear-caps must be removed carefully and the thin metal discs thoroughly wiped with a clean rag which has been

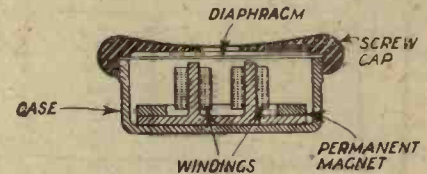
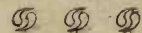

Fig. 2.—Failure in telephone receivers is sometimes caused by a break in the connection between the two coils.

previously soaked in a little paraffin. Since prevention is better than cure, a recurrence of the rust can be prevented if the exposed surface of the diaphragm is smeared over with a very thin layer of vaseline.



WIRELESS enthusiasts are often at a loss to account for a reduced efficiency in their telephones. This may be due to a variety of causes, such as the breaking down of one of the windings (shown diagrammatically in Fig. 2), or perhaps the magnets have worn and caused the flexible wire to fracture. The remedy in both these cases is, of course, obvious.

In addition, it is frequently found that the permanent magnet loses its magnetism owing to insufficient ageing during the course of manufacture, rough treatment after purchase, or through passing the steady anode current round the windings in the wrong direction. The reason for employing a permanent magnet in telephones is interesting.

The small fluctuating currents produced by the wireless signal causes a varying pull to be exerted on the diaphragms. Without the magnet this would only result in a small movement of the thin disc, but when this fluctuating effect is superimposed upon the existing pull brought about by the magnet, then a much larger movement takes place and the resultant sound is increased.

TRY THESE NEW SELECTIVE CIRCUITS

By W. S. PERCIVAL, B.Sc. (Hons.), A.R.C.S.

An interesting account of some work carried out at the Elstree Laboratories to obtain selectivity with single-valve and two-valve receivers.

ON a well-designed single-valve detector used in conjunction with a good aerial, and under good atmospheric conditions a very large number of transmissions may be received at varying strengths. By the addition of one or two stages of note magnification many of these can be brought up to loud-speaker strength.

very high resistance into the aerial circuit at the frequency which it is desired to cut out. This, however, frequently has the effect of cutting down the strength of transmissions at neighbouring frequencies which it is desired to receive. The use of two tuned circuits before a detector valve is of very considerable interest as an

two tuned circuits. It is impossible to give details for obtaining this, as the separation of the coils depends so much on their size and magnetic field. The distance, however, should be of the order of 4 to 6 inches in most cases.

Practical Results

In some practical experiments a distinct advantage was found to accrue from the use of this double reaction. This was chiefly due to the fact that it enabled the coupling between the two tuned circuits to be reduced to a very small value before the signal strength was seriously impaired. The circuit is extremely interesting, but a somewhat difficult one to handle. Selectivity is, however, of a very high order, and it was found possible at a distance of about 12 miles from London to obtain Manchester with only the very slightest background of the former.

A Separate Reaction Valve

While using the circuit described above, it was thought that a certain amount of undesired coupling between the two circuits took place through the two reaction coils which are shown in series. It was therefore decided as a matter of interest to employ an entirely separate valve to introduce

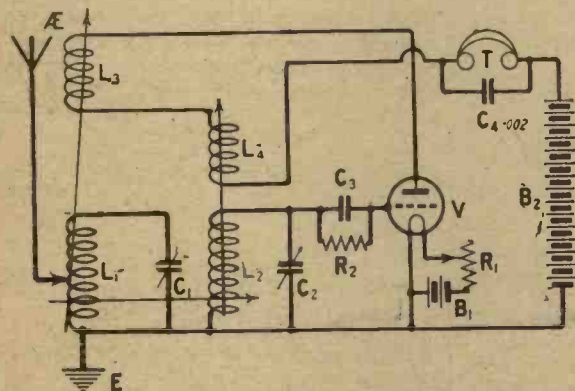

Fig. 1.—Double reaction is employed in this single valve detector circuit.

Unfortunately, a set of this type suffers from the serious disadvantage that quite a wide band of frequencies is partially or entirely blotted out by the transmission from the local station.

The Search After Selectivity

In the search after the requisite degree of selectivity necessary to cut out the local station within a small difference of frequency, several different methods have been devised. In the first place, a Reinartz or modified Reinartz circuit can be employed with which, if carefully designed, a very high degree of selectivity can be obtained. By decreasing the number of turns in the aerial circuit, selectivity can be progressively increased, but after a certain point signal strength falls at the same time. Another disadvantage from which a very selective circuit suffers is that the quality is impaired owing to the cutting off of the sidebands.

Suggested Methods

This difficulty can be removed in two different ways. In the first place a separate trap circuit can be employed, or, on the other hand, an additional tuned circuit may be added. The action of a trap circuit is really analogous to introducing a

alternative method, and although tuning is thereby rendered somewhat difficult to the inexperienced, an extremely high degree of selectivity may be obtained by this method.

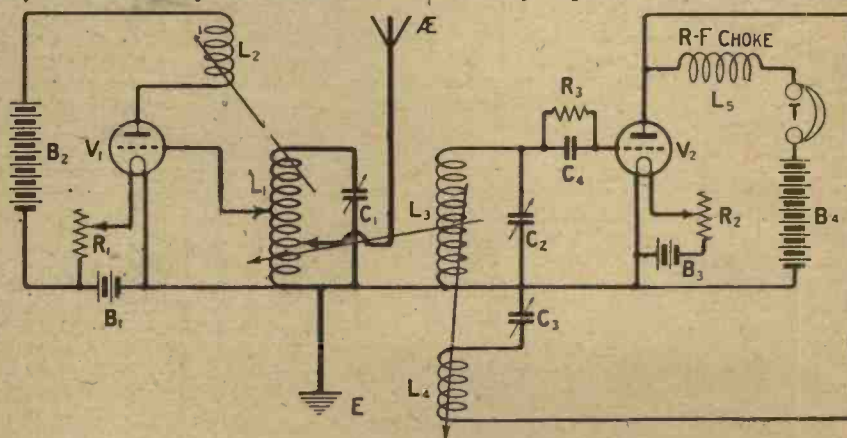

Fig. 2.—In this circuit a separate valve is used to produce reaction in the aerial circuit.

Double Reaction

In Fig. 1 we have a case in which two tuned circuits are employed for the detector, reaction being introduced on to each circuit. In order to make a set of this description function satisfactorily it is essential to have extremely loose coupling between the

reaction in the aerial circuit. The new circuit is shown in Fig. 2. In this case Reinartz reaction was employed on the detector valve with the object of simplifying reaction control. This is by no means necessary, and involves the use of rather a large number of variable condensers.

Try these New Selective Circuits—continued

Reducing the Damping

It will be noted in Fig. 2 that the grid circuit of the second reaction valve is placed across only a part of

the coupling was loosened these stations were still obtainable and the selectivity was of an extraordinarily high standard. Thus both Cardiff and Manchester could be entirely separated

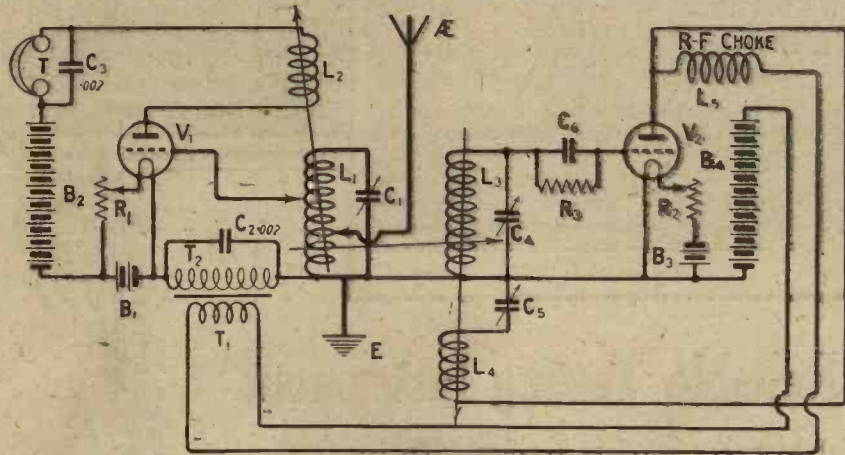

Fig. 3.—In this circuit the reaction valve is reflexed.

the aerial coil. This was done in order to limit as far as possible any damping imposed by this valve on the aerial circuit. In practice this should be almost negligible, a distinct advantage over the high-frequency and detector method of coupling two tuned circuits in which the damping of the anode circuit of the high-frequency valve is partially or wholly across the second tuned circuit.

Results Obtained

This circuit was at first very tricky to handle, but once a little experience had been gained, it was found to be much easier to obtain stations than was thought at first. It was found preferable to employ a wavemeter, but in default of this the best procedure is as follows: Having obtained the local station and noted the readings of the tuning condenser, the aerial tuning condenser should be set approximately to the reading at which the required station is expected. The reaction control associated with the special reaction valve should then be increased to a point some way short of oscillation. The tuning condenser of the detector valve, together with the reaction condenser, may then be manipulated as in a simple detector.

During the preliminary experiments the coupling between the two circuits should be moderately tight, i.e., the two coils should be about 3 or 4 inches apart. If the desired station is not obtained by this method, then the aerial tuning condenser should be altered slightly and the procedure repeated.

Good Selectivity

Using this method quite a number of stations were obtained at varying strengths in the headphones. When

from London at about 12 miles from the latter station, while quite a gap appeared to exist between London and Manchester.

stages of low-frequency amplification quite a useful receiver could have no doubt been constructed. Unfortunately, the circuit suffers from the grave disadvantage of requiring an extra valve. Actually separate batteries need not be employed, although these are shown to simplify the diagram.

A Double-Purpose Valve

It was therefore decided to attempt to use the reaction valve for a double purpose. In other words, an attempt was made to utilise this valve, not only to provide reaction on the aerial circuit, but also to act as a low-frequency amplifier. The new circuit now appears as in Fig. 3.

On trying this circuit out it was found to suffer from two distinct disadvantages. In the first place the reaction valve was very prone to howl as in a reflex receiver, and in the second place selectivity was diminished.

Partial Rectification

An examination of the circuit diagram indicated that the second fault was due to a partial rectifica-

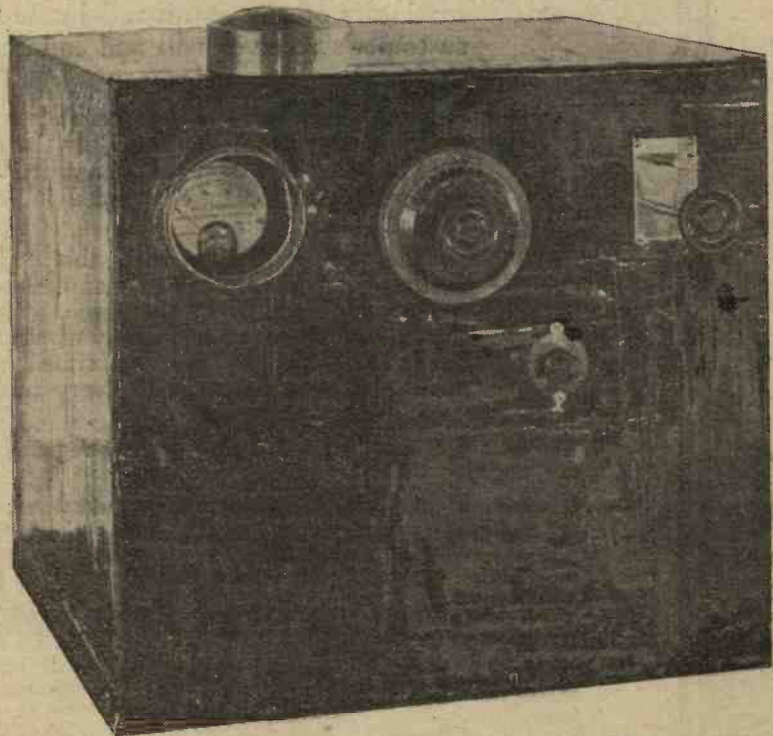

In experiments on selectivity an artificial signal is often required. This is a small transmitter, completely enclosed in a copper case so that all the energy is under control.

The Disadvantages

It will thus be seen that all the selectivity that could reasonably be desired could be obtained with this circuit, and with the addition of two

tion of the incoming wave by the low-frequency valve. In order to remove this disadvantage the grid bias on the low-frequency valve was carefully adjusted, so that no rectification should take place. This was found to



A Really Reliable Testing Instrument

is essential to every wireless retailer. To be able to satisfy himself, and his customers, that transformers, valves, batteries, &c., are in perfect condition cannot but induce pleasant business dealings. To be able to test the continuity of any circuit and locate faults in a customer's receiver will add immeasurably to the service you render.

Such an instrument has been designed and is described in detail in the July issue of **THE DEALER**. The cost of construction is very reasonable and the time occupied in building will be well spent.

The article dealing with this "Service and Testing Set" is only one of many sales-aids to the trader which appear in this issue. Produced for the wireless trade by exclusively wireless publishers **THE DEALER** is the established pre-eminent monthly journal essential to every trader.

Send for a specimen copy now and realise what you miss by not seeing a copy regularly.

Contents of the July issue include in addition to regular features:—
 Further Details of the London and Birmingham Exhibitions, an Exclusive Interview with a leading West-End Retailer, an article on "The Art of the Cabinet Maker," and "New Components for the Coming Season."

THE WIRELESS DEALER

Subscription rates:
 7/6 per annum post free.
 Abroad 10/- " " " "
 All applications *must* be accompanied by
 Trade card or business letter-heading.

Published on
 the 15th of
 every month.

All enquiries to the Sales
 Manager, Radio Press, Ltd.,
 Bush House, Strand, London,
 W.C.2.



Try these New Selective Circuits—continued

be successful in eliminating this defect.

For Experimental Work

We have then remaining the problem of howling, which was much more difficult to eradicate. A considerable degree of success was obtained by being careful not to use too much reaction on the low-frequency and reaction valve, so that this was not prone to oscillate. Although it is not probable that a circuit of the type described would be altogether suitable for the amateur to employ as a permanent receiver, yet some very interesting results may be obtained, chiefly owing to the high degree of selectivity which the receiver affords.

Adding Reaction to a Trap Circuit

It is well known that in order to obtain the best results from a trap circuit the resistance of the trap should be as low as possible. The idea then suggests itself of adding reaction to the trap in order to reduce its resistance still further. This was tried out in the circuit shown in Fig. 4. Although it is well known that a trap of this description is not the most efficient type, yet its action was considerably improved by the addition of reaction.

Overcoming Limitations

In the case of a trap the coupling is limited by two factors. If it is too loose it is impossible to cut out the local station, while if, on the other

Reaction Control Effect

A rather undesirable feature which might, however, have been suspected, was that the reaction of the trap and

It should be emphasised that all the circuits require considerable skill in handling, and should therefore only be attempted by the experienced reader. At the same time they provide

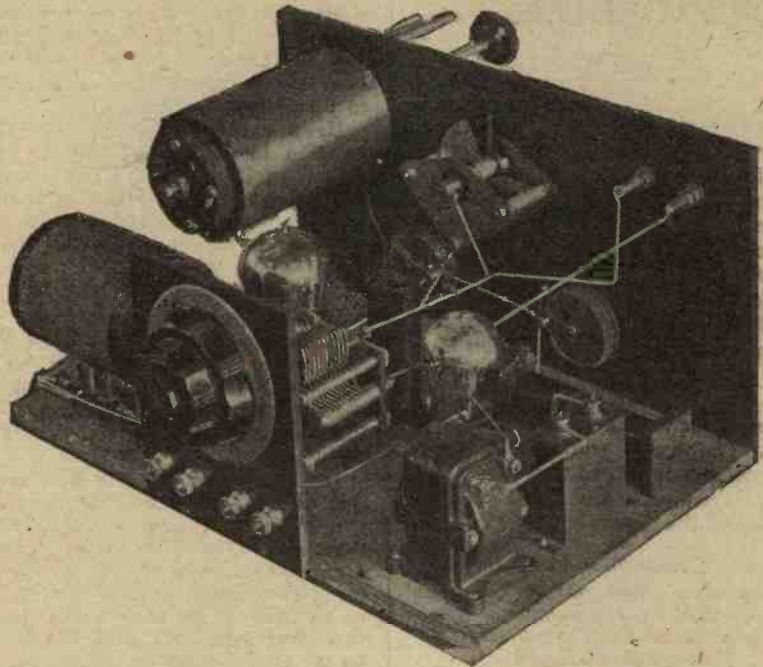

An interior view of the screened transmitter used at Elstree for research work.

the reaction of the main circuit were not independent. The reason for this is that the trap damps the main cir-

interesting food for thought and experiment for anyone who is minded to try them out.

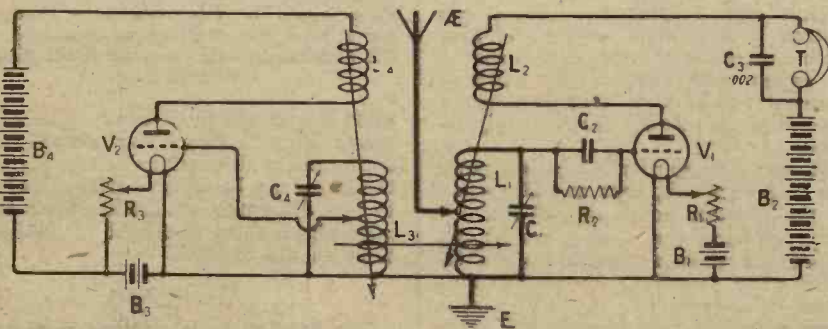

Fig. 4.—A reduction in the effective resistance of the trap circuit was made by applying reaction to it in this manner.

hand, it is too tight, then stations on either side of the local are seriously decreased in strength. By the addition of reaction it was found possible to weaken the coupling of the trap considerably, so that stations near the local could be heard with little diminution in volume, while at the same time the unwanted signals from the local station could be reduced to the required degree.

uit, thus requiring more reaction to be added, while, on the other hand, the detector circuit acts as a kind of trap on the trap circuit itself, and thus damps the latter. More reaction is therefore required on the trap circuit for this reason. Thus the two circuits are by no means independent, and it is necessary to adjust both together in order to obtain the best results.

**AN
ANNOUNCEMENT**

Concerning certain new discoveries at Elstree will be made in next month's issue of

**THE WIRELESS
CONSTRUCTOR**

The developments will be of special interest to all amateurs and home constructors.

ORDER YOUR COPY NOW

What is an anti-microphonic Valve holder

AN ANTI-MICROPHONIC valve holder is more than a valve holder mounted on springs. It is specially designed to smooth out vibration so that no shock reaches the filament. The BENJAMIN CLEARER TONE VALVE HOLDER is anti-microphonic in the full sense of the word. It "floats" the valve on springs and cushions it against vibration in every direction. Valve legs cannot touch the baseboard and the springs cannot be damaged by the tightest valve. The metal work is in one solid piece—no soldered tags to create noise. Terminals are provided in addition to the tags.

Benjamin Clearer Tone Valve Holders can be obtained at all good dealers. Do not be persuaded to buy imitations—you can always obtain Benjamin direct from the sole manufacturers.

2/9

EACH

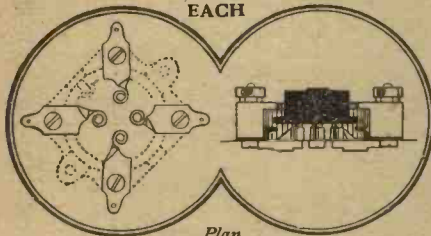

Plan and elevation of the

BRITISH **BENJAMIN** MADE
CLEARER TONE VALVE HOLDER
(ANTI-MICROPHONIC)

THE BENJAMIN ELECTRIC Ltd.
Brantwood Works, Tariff Road,
Tottenham, N.17.

Patent Nos.
222086-1923
250431-1925

Regd. Design
No. 714847

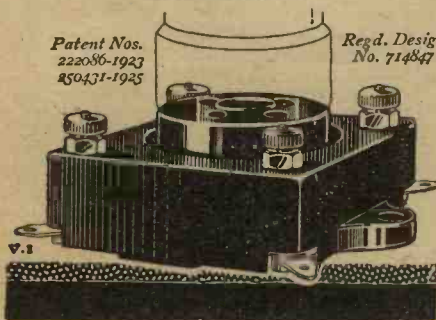

"CHANGE YOUR COIL AND CHANGE YOUR CIRCUIT"

(continued from page 905)

perienced is again found. With this adjustment made, turn C_1 again to its zero reading, and tune in the local station by means of the C_1 condenser, when by increasing the reading of C_1 signals may be made to increase in volume until to increase that volume still further may bring the set too near the point of self-oscillation, and so result in interference.

By a careful adjustment of C_1 in relation to C_2 the set may be maintained in its most sensitive condition throughout the whole tuning range of C_1 , irrespective of whether the smallest or next size coil be used.

Long-Wave Reception

When using the big coil, the reaction condenser C_2 may be neglected altogether, tuning being carried out by means of C_1 and the control of reaction being given by means of the knob situated on the top of the coil casing.

The operation of the receiver in this case is, of course, simply that of the ordinary direct coupled aerial, variably-coupled magnetic reaction arrangement, and though the adjustment of reaction in this case will not be so smooth as that given by the former circuit, little difficulty is likely to be experienced in tuning-in, say, 5XX at good strength.

Valves to Use

Practically any type of valve may be used with this receiver, and I have personally tried "general-purpose," small power and high impedance types with equal success.

The choice of valve decides to some extent the adjustment of anode voltage and filament current to give smooth reaction control, and it should be remembered that if the valve is changed for another type it may be necessary to make further adjustments.

It may be experienced, when using the long-wave coil, that any alteration of the reaction coupling will necessitate resetting the tuning condenser. This point, though somewhat of a difficulty when searching for distant stations, is, however, one of the disadvantages of using variably-coupled magnetic reaction. On the other hand, when using the Fig. 1 arrangement, it will be found that any alteration of the reaction condenser C_2 will have no appreciable effect upon the adjustment of the tuning condenser C_1 , thereby making the tuning-in of the distant stations extremely easy.

The Author's Results

The receiver has been used for some time in south-east London, and during the daylight hours Bournemouth can be received at moderate strength.

During the evening hours, when it is still daylight, though not brilliant sunshine, Radio-Belgique, Newcastle and Birmingham can be received at good strength.

On the long waves, 5XX and Radio-Paris both come in well, neither interfering with the other, while on the shorter waves hosts of Germans have been received from time to time.

A HANDY LITTLE CONDENSER

THE small variable condenser described and illustrated will have many useful applications on the constructor's bench, and since the materials employed will most likely be found on the "junk" pile, the cost incurred is a negligible item.

Dimensions Not Critical

From Fig. 1 it is seen that the condenser consists of two metal plates, one fixed and one movable, with a mica dielectric between, the capacity being varied by rotating the moving

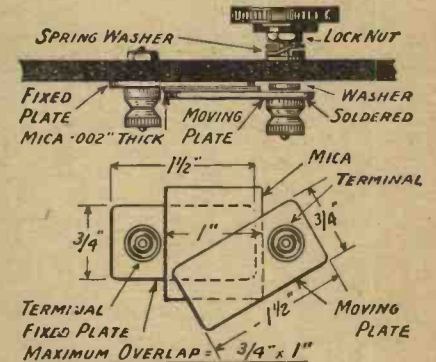

Figs. 1 and 2.—The necessary dimensions and the method of assembling the condenser will be clear from these diagrams.

plate across the fixed one. The diagram, Fig. 2, shows the shape and approximate dimensions of the plates, the latter not being very critical owing to the difference in thickness of the mica obtainable; that sold as .002 in. thick should be used.

Assembly

The fixed plate is clamped firmly to the panel by the terminal shown, which also serves for attaching the connecting wire. A little thick shellac varnish between the plate and the panel before tightening the terminal will assist in holding the plate firmly in position. The mica sheet is then fastened over the fixed plate with more shellac varnish. The mounting of the moving plate is clearly shown, and it should be soldered to the terminal to prevent it from slipping when the knob is turned.

W. E. M.

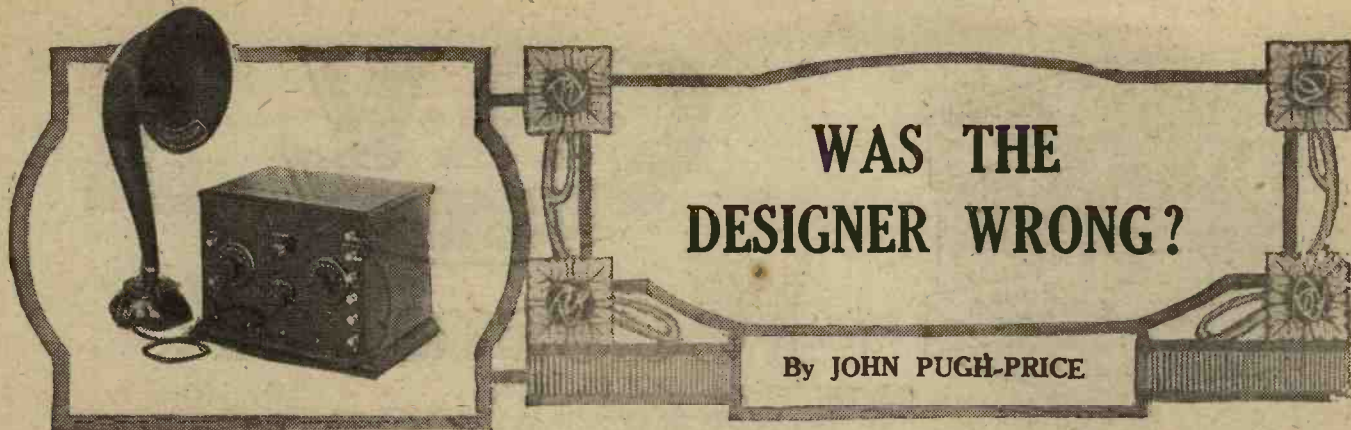

You may have followed the designer's instructions in building your receiver only to find that it will not work properly. Read this article and you will probably find where the fault lies, and that it is not in the design.

I AM sure the design is all wrong. I have strictly followed the circuit shown in Fig. 1, and can only get weaker signals than were received on my crystal set. I know all the components are correct, since I have tried them in an arrangement consisting of a crystal set and a transformer-coupled note magnifier, and also in a single-valve reaction receiver. I made this set since I understood that maximum volume and good range would be obtained by employing my single valve in a dual capacity. The components are as follows—a detailed list is given; all of the components are of reliable make.”

A Beginner's Complaint

This is a typical complaint from a beginner experimenting with reflex circuits. Often in practice the constructor, having completed his reflex receiver from a given circuit, or possibly from a published design, is confronted with this trouble. He sometimes discovers that he can lift the catwhisker from his crystal detector and still receive weak signals, whilst in extreme cases he may even find that he can only receive signals in this way, from which he often infers that the circuit or design is wrong.

A Simple Explanation

Generally there is nothing wrong with the wiring or with the design, but the valve is being worked incorrectly. Readers who have carefully followed the trend in modern design will notice there is a marked tendency to employ lower bend anode current rectification where maximum purity is the aim of the designer. No grid leak or grid condenser is used, but it is arranged that the valve shall work on the lower bend of its anode-current grid-voltage characteristic curve. This is effected by suitably connecting a grid-bias battery in the grid circuit of the rectifier, generally on the filament side of the grid coil.

Easily Rectified

The beginner in reflex circuits generally employs a comparatively small value of high-tension voltage,

for example, of 40 to 60 volts, and accidentally he may easily find that he is working his valve at or near to the lower bend in its characteristic curve. As a consequence the valve rectifies instead of amplifying at both radio and audio frequencies, as was intended. When this happens, and signal strength may be improved by lifting the catwhisker or by extinguishing the valve when a valve rectifier is employed, there is no need to be perturbed unduly, since a comparatively simple adjustment will put things right.

Working the Valve Correctly

For amplification at both high and low frequencies, without distortion, it

tension voltage on the dual valve by 30 or 40 volts, or up to the maximum permitted according to the maker's specification, whilst it will be necessary to adjust grid bias with some care in order that the best working point may be chosen. The valve then amplifies at high and low frequencies and gives negligible rectification effects.

Inserting a Grid-Bias Battery

Where provision is not made for inserting a grid-bias battery this should be placed in the position indicated by dotted line in Fig. 1. A 6- or 9-volt grid-bias battery, tapped in 1½-volt steps, should prove adequate, and if adjustment is made of this voltage and also of the H.T.

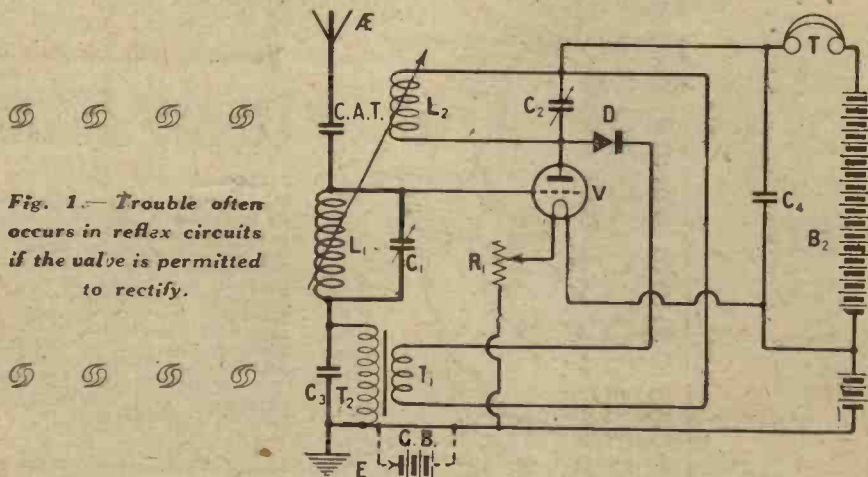

Fig. 1.— Trouble often occurs in reflex circuits if the valve is permitted to rectify.

is essential that the working point of the valve on its characteristic curve should be upon the straight portion, which latter should be to the left of the grid-volts zero ordinate. As long and as straight a working portion to the left of the above-mentioned ordinate is required to give pure reproduction, which will be obtained if there is adequate grid-voltage swing without the lower bend being reached or the part of the curve where grid current flows being employed.

This condition of affairs may usually be obtained by increasing the high-

voltage, in practically all cases difficulty due to rectification by the dual valve will be overcome.

Final Adjustment

Before final adjustment of H.T. and grid-bias voltages is made it is necessary to find a sensitive spot upon the crystal which will necessitate a slight readjustment of both tuning and reaction controls. When the crystal is brought into circuit the effect is to increase the damping, making it necessary to bring the reaction or anode coil towards the aerial coil. It



Car Equipment
Manufacturers by
Appointment to
H.M. THE KING

Pedestal of 35 Years Experience



C.A.V. H.T. ACCUMULATORS are not built of the ordinary test tubes, but tubes of special design and material assembled to eliminate intercell current leakage, which is so common amongst block form accumulators of much greater capacity; which large capacity is, in many cases, superfluous. An H.T. Accumulator need not necessarily have a large ampere hour capacity, because the current taken by the average broadcast receiver is comparatively small, and therefore the greatest feature must be the absence of intercell current leakage and consequent maximum retention of charge. The C.A.V. H.T. ACCUMULATOR possesses this most important feature, the path of intercell leakage being more than 9 in.—an exclusive design.

That is why the leading experimenters, such as—

Mr. W. K. Alford, radio 2 DX.

Mr. V. E. M. Oliver, B.A.; A.M.I.E.E., radio 6 BV.

Mr. J. A. Partridge, radio 2 KF.

Mr. E. J. Simmonds, M.I.R.E., F.R.S.A., radio 2 OD.

use them when carrying out noteworthy experiments.

C.A.V.

C.A.V.

H.T.3.—60 Volts 60/-

H.T.4.—30 Volts 30/-

All C.A.V. H.T. Accumulators are supplied fully charged (First charge free).

For your L.T. supply— "ACTON" ACCUMULATORS in glass.

The specially designed stout moulded glass jar has many important features in addition to its transparency. It prevents the risk of fire, eliminates frothing, is clean and of good appearance. No separators are fitted between the plates, which are correctly spaced by grooves moulded in the sides of glass jar. The plate sections are suspended from the ebonite lid which is sealed in position. Screwed vent plugs are made of porcelain and therefore easily cleaned.

2-VOLT SINGLE CELLS.

TESTED CAPACITY.	WEIGHT LBS.		PRICE
	ACTUAL	DRY. WET.	
60	30	7 8	13 6
80	40	9 10½	16 0

4- and 6-volt assemblies at proportionate prices.



Inspect them at your local radio dealer or any of our Service Depots

C.A. Vandervell & Co., Ltd.
WARPLE WAY, ACTON, LONDON W3

Telephone: Chiswick 2000.

Telegrams: "Vanteria, Act, London."

Also obtainable at the following Depots:

BIRMINGHAM... (LUCAS)... GREAT HAMPTON STREET	MANCHESTER... (LUCAS)... 277, DEANSGATE	MANCHESTER... (LUCAS)... CHESTER ROAD, STRETFORD
"Lucas-Birmingham,"	"Grams: Northern 2201	"Grams: Lumina-Manchester."
BRISTOL... (ROTAX)... 7 TEMPLE STREET	"Grams: Rotax-Bristol." Phone: Bristol 5736	MANCHESTER... (LUCAS)... CHESTER ROAD, STRETFORD
COVENTRY... (LUCAS)... PRIORY STREET	"Grams: Lucas-Coventry."	NEWCASTLE-ON-TYNE... (LUCAS)... 88, ST. MARY'S PLACE
"Lucas-Coventry."	Coventry 1868	"Motellit-Newcastle-on-Tyne."
GLASGOW... (LUCAS)... 227/229, ST. GEORGE'S ROAD	"Grams: Lucas-Glasgow."	LEEDS... (ROTAX)... 117, PARK LANE
"Grams: Douglas 3075-0		"Grams: Rotax, Leeds."

Was the Designer Wrong?—continued

is required, therefore, that compensation for the introduction of the crystal be made by a slight readjustment of the reaction setting and of the tuning on both condensers before final adjustment of H.T. and grid-bias voltages can be made finally.

By-Pass Condensers

In the circuit of Fig. 1 it will be observed that the by-pass condenser C_1 is connected both across the telephones and across the high-tension battery. In this position, therefore, it is essential that a suitable size of condenser be employed, and here generally .001 or .002 functions well in practice. In a case which I recently investigated, a 2-microfarad Mansbridge type was employed here, and it was complained that signals were extremely weak and poor in quality. This, of course, is only to be expected, since it should be realised that a large condenser, such as that mentioned, not only by-passes the high-frequency component, which it is intended to do, but also acts, to a large extent, in a similar capacity to audio-frequency currents.

The result is therefore practically equivalent to partially short-circuiting the telephones. Where a Mansbridge type condenser of 1 or 2 microfarads is employed it should be connected across the H.T. battery only, and a further by-pass condenser of .001 or .002 should be connected directly across the telephones.

coil and one transformer-coupled note magnifier, illustrates other faults which often perplex the beginner. Here a usual complaint is that the H.F. stage does not give the step-up

circuit will be required when the detector valve forms the first valve of the receiver. Even when attention has been paid to these points the difficulty may still be present, and other

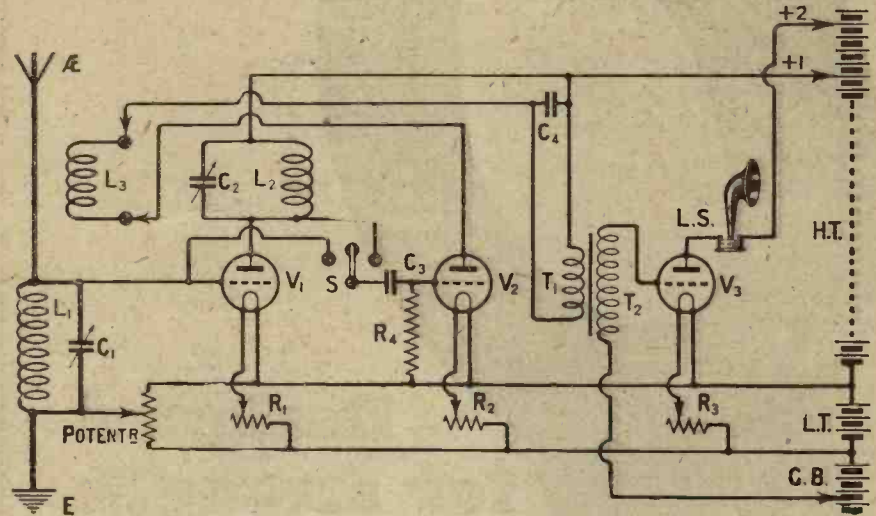

Fig. 2.—Unless correctly adjusted a high-frequency valve may give little or no amplification.

in signal strength on distant stations which it should, or may even be responsible for a step-down in amplification. The first point which should naturally occur to the experimenter is the fact that a reversal of reaction

sources must be explored to locate the fault:

A Simple Cause

At this advanced stage in broadcasting receiving apparatus it would seem unlikely that lack of skill in tuning could be responsible, but in a number of cases this, coupled with the employment of an unsuitable valve in the H.F. valve socket, and incorrect H.T., etc., is often the cause. Unless the tuned-anode circuit is tuned correctly to the wavelength of the station it is desired to receive the H.F. valve will prove a hindrance rather than a help in obtaining good signals. A few words on tuning the set may therefore not come amiss.

Sequence in Tuning

Until the feel of the receiver has been obtained logical sequence in tuning should be followed. Normally the anode circuit will tune more sharply than the aerial circuit so that in searching a satisfactory system to adopt is to advance the aerial condenser by one or two degrees at a time, whilst taking the anode condenser through the whole of its scale divisions slowly. If you do not feel competent to adjust the coupling of the reaction coil at the same time so that the set is kept just below the oscillation condition, in which it is most sensitive, some intermediate setting should be obtained so that the receiver does not oscillate on the lower degrees of the two condensers,

(Continued on page 930.)

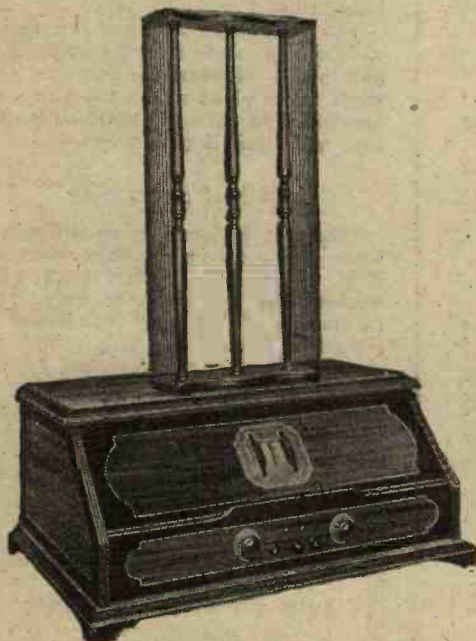

A Useless H.F. Stage

The theoretical circuit diagram of Fig. 2 showing a general-purpose 3-valve arrangement in which a tuned anode H.F. stage is followed by a detector, with reaction on to the aerial

connections is necessary when the H.F. stage is cut out of circuit. This, however, can usually be effected by means of two short flex leads and suitable plugs.

A larger size of reaction coil than is necessary when the H.F. valve is in



A handsome American receiver—the Radiola 25





Designed for strength

AT last there is a Coil which is not only electrically perfect, but is also mechanically strong—most coils are flimsy in construction, and after a little use become shapeless. The Eureka Low Loss Coil is so made that the greatest strength is in the base which bears the most strain. The ebonite rib, situated immediately above the plug, allows repeated removal from the socket without any damage whatever to the coil. The solid ebonite former and band also add materially to the strength of this fine coil.

Q Low Self Capacity

There is no coil on the market which has such a low self capacity—an examination will convince you of this. The unique method of winding, and the exact spacing of the high grade silk-covered wire permit of such a minute self-capacity that sharper tuning and therefore greater selectivity must result.

Q Handsome Appearance

Mechanical strength and electrical perfection are indeed sufficient to commend the Eureka Coil, yet, there is another point in its superiority—appearance. When you see this Coil at your Dealer's you'll at once agree that it is the most handsome coil you ever saw. Its green silk wire and neat finish will enhance the appearance of any Receiver. Glance at the prices alongside and see how little you have to pay for this super Coil.

Here is the range:

E20	40-150 metres	4/3
E25	55-250 metres	4/3
E35	80-375 metres	4/3
E50	120-560 metres	4/6
E75	185-760 metres	4/10
E100	285-1000 metres	6/3
E150	360-1500 metres	7/-
E200	470-1375 metres	8/-
E250	530-2725 metres	8/6

All the above wave-lengths are obtained with a '0005 mfd. variable condenser in parallel.

Portable Utilities Co., Ltd.
(Eureka Radio Products)
Fisher St., London, W.C.1

EUREKA

Low Loss Coils

WAS THE DESIGNER WRONG?

Concluded from page 929

but at the same time is not unduly insensitive on the higher wavelengths.

When a station is heard the reaction coil should be approached towards the aerial coil gradually, whilst the settings of C_1 and C_2 should both be readjusted slightly. It will be found that each alteration of the coupling between the reaction and the aerial coils will necessitate slight retuning on both aerial and anode condensers, and if these points are borne in mind little practice should allow good results to be obtained.

A Defective Anode Coil

Occasionally a discontinuous anode coil is responsible for lack of step-up in amplification, and here the well-known telephones and dry cell test should be employed, a small dry-cell and a pair of telephones being joined in series. The free side of the battery should be connected to one side of the coil, whilst the other side of the coil should be tapped with the free telephone tag. Loud plonks will be heard if the coil is continuous, but only feeble ones if a break is present, in which case the coil should be changed. A further fault, which is not quite so common, is a short circuit of the anode coil. A short-circuited anode coil when inserted into the L_2 position will prevent signals being heard, and only when it is withdrawn will results be obtained.

The telephones and dry cell test is useless here, since a loud plonk will be obtained. Generally, however, the short takes place where the two leads are joined to the coil plug, and inspection will allow it to be located.

Lack of Sensitivity

Where it is found more difficult to make the receiver oscillate when the H.F. stage is in circuit than when working on the detector only, poor insulation of the grid condenser C_1 should be suspected. This component should therefore be replaced by one which has worked effectively in another receiver, since if the insulation is poor considerable positive bias may be communicated to the grid of the detector valve, and this will render the set unusually stable and insensitive.

HOW TO CALIBRATE YOUR RECEIVER

By Capt. H. J. Round, M.I.E.E.

See the July
"MODERN WIRELESS"

G. A. 5312

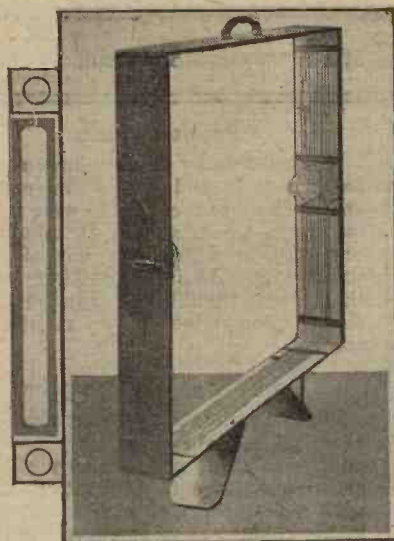

HAVE YOU MADE YOUR PORTABLE SET?

By D. J. S. HARTT, B.Sc.

NO doubt at this time of the year many readers are in possession of portable sets, while others, perhaps, contemplate building some such set in order to be able to continue their enjoyment of radio during the summer months, in their outings on the river, picnics, at the tennis club, and on their walking or motor-tours.

Some Preliminary Considerations

It is for the benefit of the latter that this article is written, in order that they may appreciate some of the consideration to be taken into account in their choice of suitable equipment. Now, generally speaking, sets for use in the open-air may be divided into two classes, first, those for use with 'phones only, and secondly, those suitable for loud-speaker work.

The former may be classed strictly as portable sets, while the term "semi-portable" is better suited to the latter class. A further sub-division renders this classification somewhat clearer. Thus we may have two further classes, according to the nature of the results which are expected from the set, namely, reception from the local station or Daventry only, or reception of distant stations as well.

What Are Your Requirements?

There are, then, four distinct types, and before anyone contemplates building or purchasing a set for the open air, he should first of all ascertain exactly what his requirements are likely to be. This procedure simplifies to a considerable extent his choice of a suitable design.

If, for instance, you will be satisfied with 'phone reception of the local station it is useless to incur the expense and trouble of constructing a set which is capable of giving loud-speaker results from that station, not to mention, of course, the trouble of carrying about such a set and its associated equipment.

A Personal Opinion

Personally, I have no use for any set intended for outdoor reception which is not capable of giving at least one station on the loud-speaker at reasonable volume. However, this is, of course, solely a personal opinion, and, although I cannot see myself spending a day on the river listening at intervals to London with headphones, I realise that I may be abnormal in this respect, so I shall endeavour to write this article to present an unbiased view of the matter.

The Word "Portable"

The word "portable" has been used in rather an elastic way in reference to wireless receiving equipment, but

To describe a four-valve set, say, H.F., detector, and two transformer-coupled note magnifiers, with its associated equipment, as portable is rather stretching the meaning of the term. I have unpleasant recollections of carrying a similar type of set, together with batteries and loud-speaker, a distance of about half a mile. Such a set is portable only so far as the motorist is concerned.

Suitable Circuits

You may ask what is the best circuit and number of valves you will require for any given purpose. In the first place, this depends to some extent on what type of aerial you propose to use. It is always wise to erect the best possible aerial that circumstances will

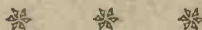

Considerable enjoyment can be obtained with a set which will only give telephone strength.

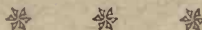

I do not think that it should be applied strictly to any apparatus which is not completely self-contained and which does not entail any greater effort in carrying than does an average-sized attaché case, containing, say, business papers.

permit, but do not count on always being able to sling a wire from a fairly high tree.

Straight Circuits

Assuming, first, that you are able to do this, and that you will, there-

Have You Made Your Portable Set?—continued

fore have an aerial approaching in efficiency the average outdoor aerial, then you will probably not need more than a single valve for 'phone reception of the local station at distances

provided with a terminal usually serves the purpose quite well. Where the earth is dry two such earth connections, connected together, will prove more satisfactory.



An aerial slung over a tree is quite suitable for outdoor work.

up to twenty miles, and two valves, detector and one L.F., transformer coupled, should give you a fair margin of safety for 'phone reception of 5XX practically anywhere in the country under these conditions.

For moderate loud-speaker reception in each case, an extra transformer-coupled L.F. valve will probably suffice, but it must be realised that local conditions will to some extent affect these considerations, so that no hard and fast rules are possible.

Smooth Reaction

Generally speaking, whatever type of temporary aerial you erect, it may be safely said that its resistance will be fairly high, so you will be wise to incorporate some method of smooth reaction control in straight circuits of this type. That usually attributed to Reinartz, or some similar method, is to be preferred. You can then increase the reaction gradually until the point is reached when the extra aerial resistance has been balanced out and provided no further reaction is used the quality of reception should not suffer.

Your Earth Connection

The earth connection is important, and here again it is wise to provide the best possible in the circumstances. This should present no undue difficulty if moist soil is available, for practical experience shows that a 2- or 3-ft. length of the so-called "brass" curtain rod driven into the ground and

Suiting Local Conditions

If you are fortunate enough to be near a lake or stream, a length of bare wire thrown into the water will give you a good earth connection. Where



A good example of a portable superheterodyne receiver which was described by Mr. G. P. Kendall in the May issue of "Modern Wireless."

there is a gravel soil the problem is more difficult, and practically the only satisfactory solution is to use a counterpoise. This should be supported about 5 or 6 ft. from the ground upon two poles or other temporary supports, and well insulated. It should extend under the aerial and be slightly longer if possible.

Freak Aerials

No doubt many readers have read of freak aerials and earths for outdoor use, such as connection to wire fences, using the sap of a tree, etc., but it is not wise to depend on any of these substitutes. It is interesting to try them experimentally, however, for they often give very satisfactory results.

Loud-Speaker Reception

Returning again to the consideration of suitable circuits, suppose you are unable to erect a reasonably efficient aerial and have to be content either with a frame aerial such as is found in the cabinet of some portable sets or with only a small aerial of the ordinary type. Well, in such cases the same circuits may be used as before, but a stage of high-frequency amplification added to compensate for the relatively inefficient collecting system.

The method of high-frequency amplification used should be simple and easy to control, and either one of the neutralised methods or some such scheme as a "parallel-feed" stage may be incorporated with confidence. Where extreme simplicity is called for, an "aperiodic" transformer coupled stage has much to commend it, though naturally the amplification is not so large.

Reflex Sets

The reflex principle has a certain application to sets for outdoor use when only the local station or

Davenport is required, and provided a good design and first-class components are used, there is no reason why a reflex set should not be successful. Though you may not get exactly the equivalent of two ordinary stages of amplification, one valve is certainly saved, and this is a commendable feature, where portability is concerned.

HAVE YOU MADE YOUR PORTABLE SET?—continued

Superheterodyne Receivers

The superheterodyne has great possibilities for powerful semi-portable receivers, and, indeed, it is practically the only type of set which will adequately satisfy the requirements of those who want reception of distant stations with only a small aerial or frame aerial.

With six valves a very successful set may be made, and for a well-tryed design the reader is referred to "A Superheterodyne for the Open Air," designed by Mr. G. P. Kendall, and described in the May issue of *Modern Wireless*.

This set employs an "aperiodic" stage of high-frequency amplification at signal frequency, a combined first detector and oscillator, two stages of intermediate frequency, second detector and one stage of low-frequency amplification.

Reflex Superheterodynes

Though not much work seems to have been done in this respect, there are great possibilities in reflex superheterodyne sets for portable uses—that is to say, superheterodynes in which one (or more) of the intermediate stages is reflexed, thus making this valve function as a low-frequency amplifier as well. A five-valve circuit was published some time ago in which the three intermediate stages were reflexed on the Grimes' Inverse Reflex principle, but it does not seem to have achieved the popularity which was apparently justified from the author's claims.

General Design

There are one or two points in the design of portable sets which call for special consideration. First, there is the choice of valves. Generally speaking, valves of the 3-volt, .06-ampere type will satisfy most requirements, while power valves taking .1 ampere at 4 volts seem to be the most suitable. It is, I think, generally agreed that a small four-volt accumulator of the "unspillable" type is to be preferred to the more cumbersome and weighty dry batteries, which have to be of large size to supply safely the current for three or four valves.

There is now on the market a two-volt valve taking .06 ampere filament current. Although I have not tried this valve, it would seem to be a useful type to incorporate in portable receivers.

Keep the Battery Sizes Small

High-tension batteries should be as small as possible consistent with not too large a load being taken from them. About 5 milliamps. is the safe maximum which can be taken from the ordinary small type of battery over any length of time, and if your

total H.T. current exceeds this figure it will probably be more satisfactory to utilise two of this size of battery in preference to the heavier and more bulky type employing larger cells. In most medium-powered portable sets it is possible and more convenient to provide a separate compartment in

In this type of portable receiver provision is made for carrying all the accessories in the case.

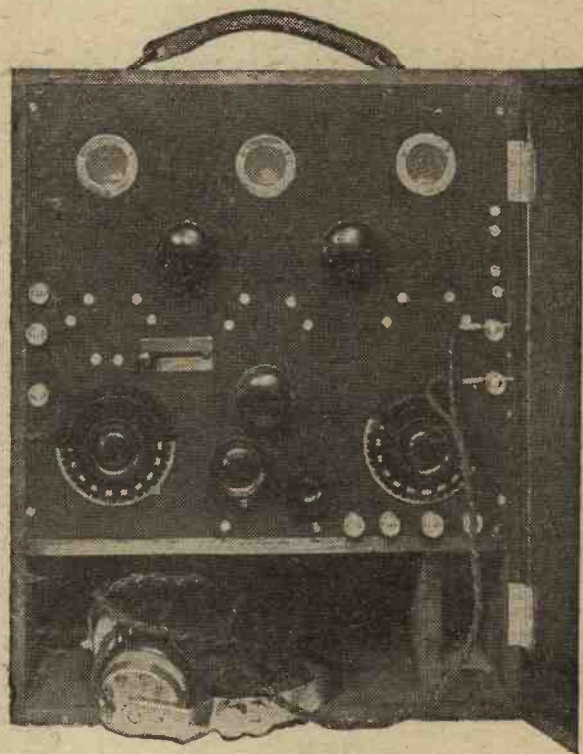

the case to house the batteries, 'phones and aerial wire, together with any minor accessories which may be necessary.

Good Joints Essential

No matter what type of set is employed, it is wiser to safeguard your valves against rough treatment by providing some good valve holders of the vibratory type.

Incidentally, special attention should be paid to the soldering of all connections, each one being carefully tested to see that it is both electrically and mechanically sound. A dry joint can quite easily occur, and may spoil your enjoyment of the programme or even render reception impossible.

I think I have discussed in sufficient detail all the considerations which will influence your choice of a portable set, and I trust these details will be of some assistance to those who are contemplating building a set for the enjoyment of radio in the open air this summer.

a similar rating is the Cossor "Stentor Two," also described. The new Metrovick S.P.18/B (Blue Spot) valve is of the same type, but its filament consumption is only 0.09 amps, at 2 volts.

Messrs. Igranic Electric, Ltd., and also Messrs. Jackson Bros., are advertising dual condensers of a type suitable for incorporation in the "Elstree Six" and similar receivers.

A new precision condenser is also described by Messrs. W. G. Pye & Co. This is supplied with a 200-1 ratio vernier drive, complete freedom from backlash being claimed.

In connection with neutralising condensers, Messrs. Gambrell Bros., Ltd., point out that they are now marketing a direct-reading dial for their well-known "Neutrovernia" condenser, which will enable the user to make an instant return to settings previously logged. No alteration to the existing condenser is necessary.

NEWS FROM ADVERTISEMENTS

SEVERAL noteworthy advances in valve design will be found mentioned in the advertisements in this issue. The Mullard Wireless Service Co. give details of the new PM-1, a 2-volt valve, and a valve working at



**CRYSTAL RECEPTION
IN AUSTRALIA**

Sir,—Two years ago I and a fellow enthusiast "went in for wireless," and built a loose-coupled crystal set which was completed by the end of February. We connected up and started listening in from Goomen in the South Burnett district (100 odd miles north of Brisbane) and tried to pick up 2FC at Sydney. Plenty of spark came through but not 2FC. We persevered, and in May (our winter time) actually got them at good 'phone strength. Finances did not permit a condenser, and all the tuning was done directly from the loading coil, which was operated with two switches.

We listened in regularly after this with two pairs of telephones. Daytime reception was nil, and only when the sun had set for about 1½ hours could we get 2FC. Two other local people built similar sets and got the same results, although farmers are over 600 miles away.

The following particulars may be of interest to you and your readers. Coils—two cardboard cylindrical formers, diameter 3½ in. and 4 in., length 6 in. These were thoroughly shellaced and dried. Primary winding 125 turns of 24-s.w.g. enamelled copper wire (unspaced). Secondary, 165 turns 26-s.w.g. wire. The completed coils were then shellaced again and baked in an oven. The crystal cup was a valve cover from a car, and the crystal (just the ordinary eighteen-penny) sat on top. The aerial was of 3/20's aerial wire, 135 ft. long with lead-in, and of the inverted L type. The lead-in pointed west—2FC is south.

The catwhisker ranged from one strand of wire out of a flexible lead to a needle. Results were in all cases the same.

The surrounding country consists of high ironstone ridges heavily timbered, so that the aerial was fairly well screened. A variable condenser installed later made very little difference to the selectivity either in series or parallel. Trusting these particulars will be of interest to you.—Yours faithfully,
G. S. HALL.

North Queensland, Australia.

**NEWS
FROM ABROAD**

**THE 'POWERFUL THREE'
AGAIN**

Sir,—I am writing to let you know the results I have had with the "Powerful Three," described by Percy W. Harris, M.I.R.E., in the April, 1925, issue of THE WIRELESS CONSTRUCTOR.

I have received the following stations at good loud-speaker strength: London and Daventry (very loud),



Mr. S. L. Hogben's "Powerful Three" receiver has induced three friends to make a similar set.

Newcastle, Birmingham, Bournemouth, Brussels, Hamburg and Dublin.

I am enclosing a photo, which you may like to publish, and you will see I have altered the design somewhat. Also I have placed a Polar R.C.C. unit in the last stage of the L.F., as I do not require so much volume as I had when I first made it up. The valves employed are Mullard .06. The D.P.D.T. switch is for the purpose of having two pairs of 'phones on detector only. All battery leads are at the back of the cabinet, which is mounted on "Eddystone" shock absorbers, as this saved me buying special valve holders.

In conclusion, I may say that this set has been responsible for three people starting off with a three-valve set straight away.

Wishing THE CONSTRUCTOR a long and healthy life,—Yours faithfully,
S. L. HOGBEN.

Windlesham.

**THE MIDGET AND
SHORT-WAVE WORK**

Sir,—I read with interest the letter from Mr. Chas. H. England appearing in your May issue of THE WIRELESS CONSTRUCTOR which has just come to hand. While Mr. England is to be congratulated on his achievement, he cannot claim to have established a record in the reception of KDKA.

Using this set (the Midget) without any form of amplification I logged that station at R4 on two consecutive mornings last January. This is our best season for receiving stations in the Northern Hemisphere.

It may interest you to know that I have since mounted the panel on a baseboard with coil holder and .0005 variable condenser, the latter controlling reaction on the Grebe system. The set is now used exclusively for short-wave reception, and oscillates easily down to 25 metres. Using a 7 ft. indoor aerial I have already logged a large number of South African "Hams" as well as Bandoeng (Java), and several other commercial low-wave stations. Under separate cover I send you the only available copy of our "local mag." It is somewhat ancient, but you will get an idea of its nature. It caters almost exclusively for the amateur transmitter and the short-wave merchant. Couldn't you manage to introduce more of this stuff?

Yours faithfully,
ROBERT E. TAYLOR.

Germiston, Transvaal.

[We congratulate our correspondent on his achievement with the "Midget" receiver, and tender our thanks for the copy of his local magazine. In view of his remarks concerning short-wave work he will no doubt be especially interested in the two-valve receiver described on page 889.—Ed.]

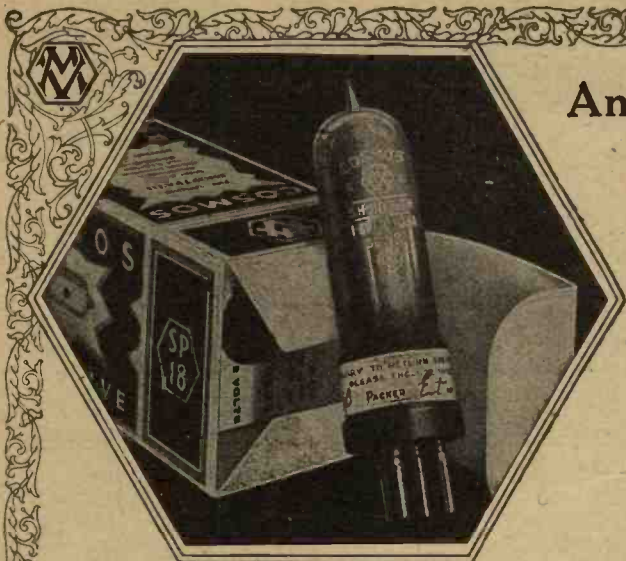

Another SHORTPATH Valve S.P. 18/B (BLUE SPOT)

This new S.P. 18 Valve supplements the well-known S.P. 18 Red Spot and Green Spot Valves. It is designed especially for use in resistance-capacity coupled sets and for use as a Detector and in H.F. neutrodyne tuned anode stages using 80-120 Volts H.T., so that where this H.T. is employed in the last stage, the difficulty of two H.T. supplies is avoided.

In addition, it gives still more amplification and consumes very little H.T. current.

The S.P./B (Blue Spot) is an excellent valve for anode bend detection.

Designed to work in parallel with the S.P. 18 Red Spot and Green Spot Valves, it operates from a 2-volt accumulator and consumes only 0.09 amp. filament current.

PRICES OF "COSMOS" SHORTPATH S.P. 18 VALVES.

RED SPOT.	GREEN SPOT.	BLUE SPOT.
12/6	12/6	12/6

METRO-VICK SUPPLIES, LTD.

(Proprietors: Metropolitan-Vickers Electrical Co., Ltd.),
METRO-VICK HOUSE, 145, Charing Cross Road, LONDON, W.C.2

"Cosmos" SHORTPATH S.P. 18 Valves are recommended for use as shown below with alternative H.T. values:—

Stage.	Coupling	Recommended Valves H.T.	
		20-80 V.	80-120 V.
H.F. Amplifier	Tuned Anode (neutrodyne)	Green	Blue
	Tuned Anode (not neutrodyne)	Green	—
	Transformer (loose coupled)	Red	—
	Transformer (tight coupled)	Green	—
Dual or Reflex	All Couplings	Red	Red
Detector (Grid Leak)	Resistance Coupling	—	Blue
	L.F. Transformer or Choke	Green	Blue
Detector (Anode Bend)	All Couplings	—	Blue
L.F. Stages	Resistance	Green	Blue
	L.F. Transformer or Choke	Green	Green
Last Stage	All Couplings	Red	Red



SUBSCRIPTION RATES

FOR RADIO PRESS JOURNALS.

MODERN WIRELESS

15/- per annum United Kingdom.
13/6 per annum Canada and Newfoundland.
15/- per annum Other Countries.
Lesser periods than 12 months pro rata.

THE WIRELESS CONSTRUCTOR

8/6 per annum United Kingdom.
7/6 per annum Canada and Newfoundland.
8/6 per annum Other Countries.
Lesser periods than 12 months pro rata.

WIRELESS

(Incorporating *Wireless Weekly*)

13/- per annum United Kingdom.
13/- per annum Canada and Newfoundland.
13/- per annum Other Countries.
Lesser periods than 12 months pro rata.

THE WIRELESS DEALER

(Available to the Trade only)

7/6 per annum (10/- abroad).

N.B.—Business letter heading or trade card must be sent with subscription.

RADIO PRESS LIMITED,
Bush House, Strand, London, W.C.2

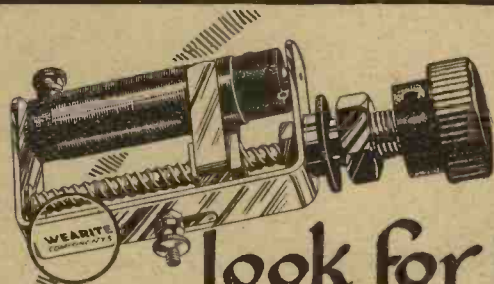

look for it

You can tell them by accurate assembling. These all-British qualities assure best reception at a very reasonable cost.

Illustration shows a Wearite Vernier Control Filament Rheostat. Q. 11 (7 ohms) 3/6; Q. 12 (30 ohms) 3/9; P. 12 (300 ohms) 4/6. Elements are interchangeable and can be supplied separately with resistance values plainly stamped on each.

WEARITE COMPONENTS

WRIGHT & WEAIRE LIMITED,
740, High Road, Tottenham, N.17.

186-2

Write for free list.



A HOME-MADE VERNIER CONDENSER

By P. H. WOOD, B.Sc., F.P.S.L.

A simple method of making a useful component.

AMONG the uses to which variable condensers of small capacity may be put, probably those most familiar to readers of *THE WIRELESS CONSTRUCTOR* are their employment for fine tuning and as neutralising condensers for controlling oscillation in H.F. amplification circuits.

Fine Tuning

When a small variable condenser is connected in parallel with the larger condenser normally used for tuning any particular circuit, the circuit may be coarsely tuned by the larger instrument in the usual manner, while fine adjustments can be carried out by means of the small condenser. Since the two condensers are in parallel their effective capacity is equal to the sum of their individual capacities, and hence the tuning range of the original arrangement remains practically unaltered by the addition of the auxiliary "vernier" condenser if the capacity of the last-named is small.

Hence the employment of a small variable condenser in conjunction with the usual tuning control provides a convenient means of carrying out the fine tuning adjustments associated with modern selective circuits, and obviates the replacement of existing condensers by new ones fitted with fine-control devices.

Preventing H.F. Oscillation

In the case of neutralised H.F. circuits a small "neutralising" condenser is connected between some point in the anode circuit of the H.F. valve and the grid of the valve, so that energy can be fed back to counterbalance the feedback due to the capacity of the valve. The neutralising condenser normally has to be so designed that it has a small minimum as well as a low maximum capacity, and many condensers fulfilling these conditions are advertised in this journal.

Such condensers are eminently suitable for the first purpose discussed above as well, so that the purchase of a good neutralising condenser should prove a good investment, as when not in use for its nominal purpose it can be incorporated in any existing set as

a fine tuning device connected to one of the tuning condensers.

A Home-Made Component

Below is described a small condenser which is quite suitable for either of the purposes discussed above. It can be quite easily and cheaply made at home, and is so designed that it takes up little panel space and is mechanically sound. It consists of a metal plate bent in the shape of half a cylinder carrying an ebonite bearing at each end. A slightly smaller semi-cylindrical plate mounted on a spindle working in the ebonite bearings forms the moving vane of the condenser, the spindle being continued and fitted with a length of ebonite rod to form a handle for control purposes.

Materials Required

Most readers will find that the materials required for the construction of this condenser can be found in the scrap box, which seems to be associated with the activities of every

Strip of ebonite about 1½ in. long by ¾ in. wide.

Two spring washers.

Length of 2 B.A. studding, 2¼ in. long.

Ebonite rod, 2½ in long by about ¾ in. diameter.

Two 2 B.A. washers, one 2 B.A. nut, and a soldering tag.

Five small round-head wood screws.

Cutting the Plates

The sheet metal should be of fairly stout gauge, and must be flattened out before use if it is bent in any way. Details of the two plates to be cut from it are shown in Fig. 1, where it will be seen that the fixed plate consists merely of a rectangular piece of metal drilled with five small holes to take the wood screws which are used to fix it to the ebonite end-pieces.

The moving plate is slightly more elaborate, being cut with a projection at either end, these projections being used as fixing lugs and drilled with holes to take the spindle. The outlines of the plates should be scratched on the sheet metal with a scribe, or marked with a hard pencil, and tin snips or a pair of strong scissors used to cut round the outline. If the edges of the metal are bent up at all during the cutting process a wooden mallet should be used to flatten them down again.

Ebonite End-Pieces

One end-piece is in the form of a circular disc 1 in. in diameter, and must be drilled with a 2 B.A. clearance (3/16ths) hole at the centre, with a further hole for fixing purposes. The other end-piece is shaped so as to form part of a similar disc in its lower part, while its upper part extends by about 1/16th inch further at each side to form a sort of shoulder against which the fixed plate of the condenser can rest. At the centre of this second end-piece a 2 B.A. hole is drilled through about half the thickness of the material, this hole forming a resting place for the end of the spindle.

The fixed plate can be bent to shape to form half a cylinder of 1 in. diameter, a wooden mallet or similar handle forming a suitable mandrel for

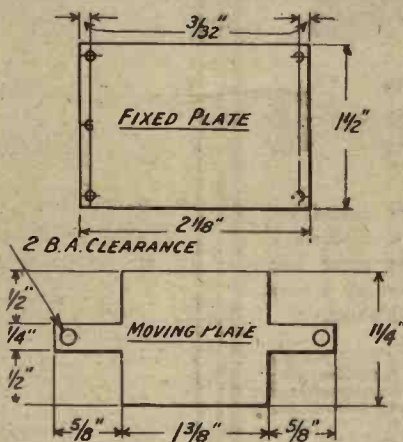

Fig. 1.—The details of the two plates can be obtained from this figure.

wireless enthusiast. In any case an outlay of a few pence will be sufficient to satisfy the requirements, and a list of the necessary materials is appended:—

A few square inches of sheet metal, preferably brass.

A circular disc of ebonite 1 in. diameter, 3/16 or ¼ in. thick.

AN EFFICIENT INDOOR AERIAL

THE main problem of wireless from the point of view of a large number of would-be enthusiasts is the aerial. This applies particularly to those who live in flats, and who do not find it convenient to erect an outdoor aerial. Quite good results, however, are possible when using an indoor aerial erected in one of the rooms of the house, and this article describes how to make such an aerial with very little trouble and a small outlay. The writer has used such an aerial for reception with several different receivers, and has found it gives excellent results. The items enumerated below must first of all be procured.

Material

- 100-ft. roll of 1/4 in. wide copper ribbon.
- One dowel rod, 3 ft. 6 in. long by 3/8 in. diameter, or an ebonite tube or rod of similar dimensions.
- One length of brass bar, 3 ft. 6 in. long by about 3/16 in. diameter.
- One spring clip.
- A piece of brass strip about 2 in. long by 1/2 in. wide.
- A length of insulated flex for the down lead.

Preparing the Copper Ribbon

The details of construction are extremely simple, as will be seen from the diagram, which shows the completed aerial. First measure the distance across the room where it is in-

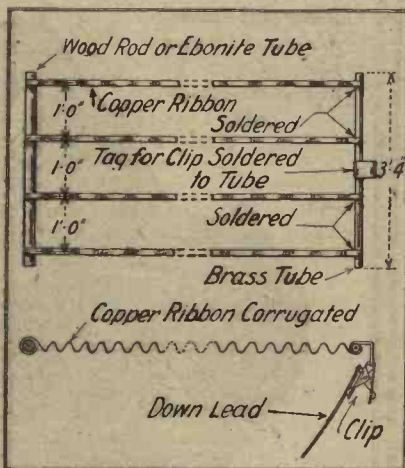

An indoor aerial constructed from corrugated copper ribbon will prove quite satisfactory in practice.

tended to erect the aerial. If this distance should be, say, 12 ft., double this figure and cut off four lengths of copper ribbon, each length thus being 24 ft.

Now corrugate these lengths of ribbon, as shown in the lower

portion of the drawing, simply by making bends in alternate directions at equal distances along each length. This process should be done with the fingers and not with pliers, as the bends must not be too sharp.

Now secure one end of each of the four strips to the dowel rod at distances of one foot apart as shown, a small pin nail driven through the copper strips at these points effectively holding them in position. The remaining ends of each of the four pieces are next soldered to the brass bar, also at distances of one foot apart. Finally, a small piece of brass strip is soldered to the brass bar in the position indicated.

Erection

All that now remains is to erect the aerial in the room chosen by securing a string across the dowel rod and the brass bar respectively. The string at each end may in turn be attached to insulators connected to hooks provided in the opposite walls of the room. A down lead should finally be made from a suitable length of insulated flex, one end of which should be equipped with a spade tag or terminal for the purpose of connecting to the receiver, while the other end should have joined to it a spring clip for connecting to the aerial via the brass strip tag provided. This arrangement enables one to completely disengage the down lead from the aerial itself when desired.

H. B.

—supreme in practice for Neutrodyne and Super-Het

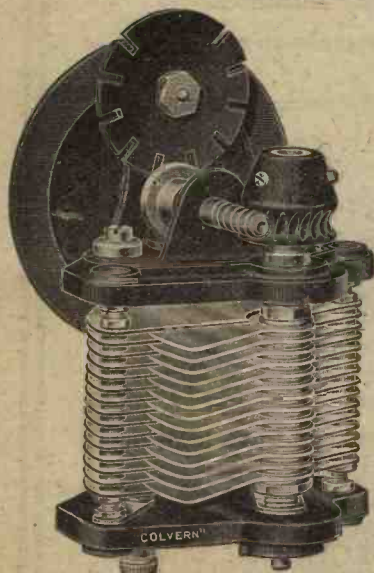

In this advertisement we print a letter of remarkable interest:—

"I consider your Selector to be the only Variable Condenser which is suitable for the Split Coil Neutrodyne Circuits. Both the rotor and stator are at High Frequency potential and with most Condensers this means that hand capacity effects are so troublesome as to make the circuit 'not worth while.' I find, however, that your Selector—even in this circuit—is quite free of hand capacity."

A Dual Selector Condenser for the Elstree Six. Price £6 Set of Four (32/8 each).

Connecting Bar and additional support for Converting 2 Selectors into Dual Selector, 5/-.

The Colvern Selector Low Loss. Reading to 1/8,600th capacity.
Capacity .0005 mfd. £1 1s. - .0003 mfd. 21 Type F. without rear attachment.
Capacity .0005 mfd. 15s. 0d. - .0003 mfd. 14s. 0d. One hole fixing. Other capacities if required.
Descriptive folder upon request.
Colvern Independent Vernier - Price 2s. 6d.
Ask your dealer also for the Colvern Low Loss Coil Former - Price 6s. 0d.

Collinson Precision Screw Co., Ltd.
Walthamstow, London, E. 17.
Provost Works, Macdonald Rd.
Telephone—Walthamstow 532.

YOURS FOR 20/-



The 'Tonyphone' G.II. is a two valve receiver of remarkable selectivity, having a range of well over 1,000 miles. Receives all B.B.C. and most Continental Stations. Will be sent on approval complete with all Accessories on receipt of 20/- You pay a further £1 each month or 5/- each week afterwards until completed.

The 'Tonyphone' G.II. In handsome Mahogany Cabinet Complete with Accumulator, H.T. Battery, Aerial, 1 pair of 4,000 ohms Headphones and 2 Valves—1 High Frequency and 1 Detector. All Royalties paid. Illustrated Price List free on application.

Send to-day and enjoy broadcasting NOW.
BRITISH ENGINEERING PRODUCTS CO.
(Battery Dept.), Abbey House, Victoria Street, London, S.W.1
S.S.A.

CUT THIS OUT FOR CABINETS

and post to us for FREE list illustrating Cabinets as shown in "Wireless Constructor," etc., etc.

NAME.....
ADDRESS.....

(Write in block letters please.)



CARRINGTON MFG. CO., Ltd.
18/20, Normans Buildings,
Mitchell St., Central St., E.C.1
Trade enquiries especially invited.

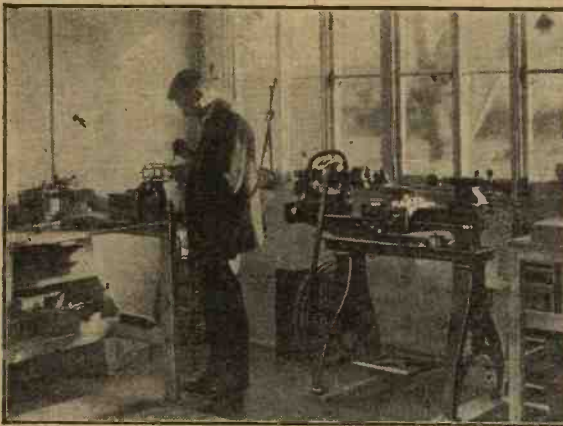

WORKSHOP HINTS FOR THE HOME CONSTRUCTOR

Ebonite Mouldings—Another Threading Tip—Centring Round Rod—Rapid Tapping—A Handy Saw—Making a Straight Cut—Salvaging Terminals—Ill-Fitting Screws and Nuts.

EBONITE MOULDINGS

I WONDER how many readers have discovered the large variety of ebonite mouldings that is now available? So many kinds are made that an enormous amount of cutting and shaping work is saved by their use. Fig. 1 shows one type that I have found especially useful. This is $1\frac{1}{8}$ in. by $\frac{9}{16}$ in. in section, and running through it are two quarter-inch holes spaced $\frac{1}{16}$ in. apart. This moulding can be obtained in 36 in. (or shorter) lengths, and it enables coil mounts to be made with an absolute minimum of trouble. All that is necessary is to cut off about one inch and to insert into the holes a standard plug and socket; these are kept in position by a pair of screws or terminals that also form the contacts.

Fluted Rod

Another very handy kind of material to keep in stock is fluted ebonite rod, which can be obtained in all diameters from $\frac{1}{8}$ in. to $1\frac{1}{8}$ in. When a supply of this is available the task of making small knobs for spindles, control levers, and so on, is immensely simplified, for all that need be done is to cut off a $\frac{1}{4}$ or $\frac{3}{8}$ in. length, to finish off the ends, and to make a tapped hole in the centre. If a lathe is available, really elegant knobs can be turned up from fluted rod.

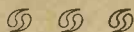

ANOTHER THREADING TIP

I DESCRIBED recently in these notes a simple method of threading ebonite rod intended for use as

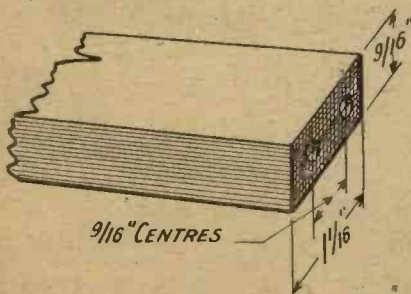

Fig. 1.—Ebonite mouldings such as that illustrated can be used for a variety of purposes.

the formers of fixed resistors by means of a split gas die. Lately I have been employing a method which is even more satisfactory and quite as easy to put into practice. It consists in the use of $\frac{3}{8}$ -in. ebonite rod, which is threaded by means of a standard Whitworth die. This makes a thread with sixteen turns to the inch and allows approximately one inch of wire to be wound on for each turn. For dull-emitter valves No. 30 Eureka wire, which has a safe current capacity of .59 amp., is quite suitable, and the resistance of this wire runs out to a little under six ohms per yard. It will be found quite an easy business to thread the rod if the die is "spread" as much as possible by means of the pointed adjusting screw in the middle of the holder.

A Cheap Outfit

Since ebonite is rather hard on steel tools I did not care about using my own best quality die for the purpose; instead, I bought a $\frac{3}{8}$ -in. die from Woolworth's for sixpence, which does the work very well indeed. As a holder can be purchased for the same price, the outfit is not an expensive one! These dies are simple to use since they are made with a fairly wide "let-in" at one side, which greatly facilitates the process of starting the threads straight. Fix the rod to be threaded in the vice, allowing about an inch to protrude above the jaws. Press the die firmly on to it, and, having seen that the holder is level, make half a turn forward. You will be able to see at once if you are going straight, for if you are not the holder will wobble as you turn it. Once you have got a proper start the die can be run on quite quickly.

Use Good Quality Ebonite

It is necessary, however, to take care that it does not become clogged. The best way of ensuring this is to prod out with the point of a scriber after every few turns the chips and the dust that collect in the clearing holes of the die. Be careful, too, to purchase ebonite rod of good quality, since poor stuff cannot be threaded satisfactorily owing to the way in which it chips or crumbles.

CENTRING ROUND ROD

WHEN ebonite rod is used for fixed resistors, for the handles of control rods and so on, holes have to be drilled in the ends, and it is most

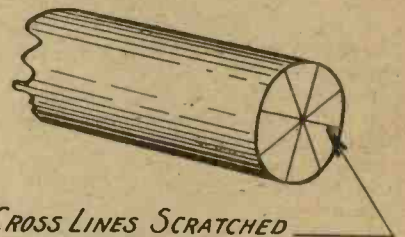
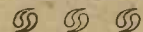

Fig. 2.—The suggested method for obtaining the centre of round rod.

desirable that these should be central, for if they are not the job when finished is always rather an eyesore to the man who prides himself on the quality of his work.

It is extraordinary how difficult it is to guess by eye the centre of the end of a piece of rod. If a punch mark is made in this way it will usually be found that the hole when drilled is considerably out of position. One of the best tips that I know for finding the centre, when a lathe is not available, is that indicated in Fig. 2. Having filed the end of the rod flat, scratch in a few crossing diameter lines with the point of a scriber. With their help the exact centre can be located quite easily, as the reader will find if he gives this tip a trial.



RAPID TAPPING

I PREVIOUSLY recommended the use of the hand drill instead of the ordinary tap-holder when it is necessary to thread a number of holes in ebonite. With either standard second cut taps or with those of the home-made variety the work can be quickly and accurately done in this way after a very little practice. There is, however, one wrinkle about rapid tapping which is probably not known to the majority of readers. One's task is made much easier if the holes are made with a rather larger drill than that given as the correct

Workshop Hints—continued

tapping size in the tables. There need be no fear that the bigger drill will make for a slack fit or for threads too shallow to hold properly. As a matter of fact, it enables quite a full thread to be put on, whilst it is much easier to start the tap straight, since its point goes further into the hole before the first critical turn is made.

Larger Drills Suggested

The use of larger drills has also the advantage that taps do not clog up so badly owing to the slightly larger

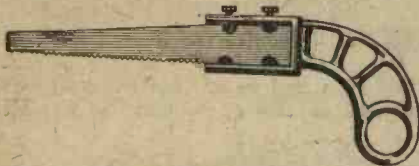
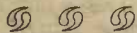

Fig. 3.—A useful addition to the workshop equipment is the keyhole hacksaw.

clearance space. For 4 B.A. the standard tapping drill is No. 34; for ebonite I always use No. 33, and the beginner who finds it difficult to go straight may find it better to use at first No. 32. A No. 42 drill instead of No. 44 is quite small enough for making 6 B.A. tapping holes, and for 2 B.A. a No. 25 may be used with advantage instead of No. 26. For threading brass or other metal it is desirable to use the tapping sizes given in the tables.



A HANDY SAW

ONE of the most useful tools that I have added for some time to my workshop equipment is the keyhole hacksaw seen in Fig. 3. This has a strong blade 5½ in. in length, which is ground almost to a point. With it the work of cutting the slots for lever switches and so on in ebonite panels is immensely facilitated, and there are many other small jobs for which it comes in very handy. The cost of these saws is only eighteenpence apiece, and extra blades are obtainable at eightpence each.

The pistol grip is very convenient, since it is a great help towards keeping the blade straight when cutting is in progress. I find this little saw much handier than the usual frame type for doing such jobs as cutting ebonite tube or rod as well as for trimming off unwanted portions of screws or studding.

MAKING A STRAIGHT CUT

A GOOD many hints have been given at one time and another on cutting ebonite with a hacksaw, but it still remains a feat which many find exceedingly difficult, for even if the blade of the saw is screwed up quite taut it shows a tendency to wander towards or away from the scribed line, largely, I believe, owing to the weight of the hacksaw frame, which makes it tend to lean to one side or the other. Here is a tip which I stumbled upon quite by accident the other day.

An Easier Process

I had drawn one scribed line, but just as cutting was about to be done it occurred to me that it might be better to reduce the length of the panel that I was cutting by ¼ in. A second line was therefore drawn, and I began to cut between the two. To my surprise I found it much easier to keep straight with this kind of marking out than when only one line was used. One can see at once when the saw twists in one direction or the other and can correct this tendency before it reaches either of the lines. When the cut has been made it is a matter of a few minutes to trim away the unwanted material with a flat file. Some may object that this is a wasteful way of cutting up ebonite, since an eighth of an inch of the material is scrapped at every cut.

Not Wasteful

Actually it is economical rather than otherwise, for when a single line only is used, one concentrates one's endeavour in not allowing the saw to run into it; hence the blade may, and occasionally does, wander quite a long way into the main piece of the material from which the smaller panel is being cut, with the result that there

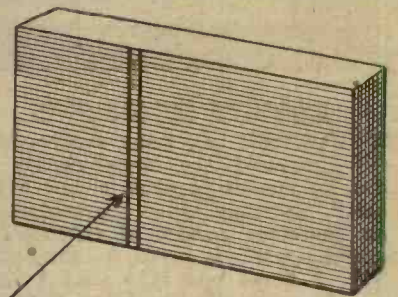

SCRIBED LINES

Fig. 4.—Double lines act as a guide when making hacksaw cuts.

is a good deal to be trimmed away as waste when another piece is required subsequently.

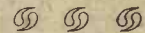

SALVING TERMINALS

EVERY experimenter's or constructor's scrapbox must contain quite a large number of old terminals which have been scrapped because their milled nuts have been lost. One of the greatest mysteries in the world is what happens to the millions of pins that are lost each year; milled nuts have an almost equally uncanny habit of disappearing in large quantities without leaving a trace. It is not generally known that these nuts can be bought from most good tool shops at very reasonable prices. Those with milled heads cost about five shillings a gross, and it is most useful to keep a supply of them in your workshop drawer.

Make Your Own

Another very useful type of terminal top is the wing-nut, which is easy to tighten down firmly and which allows connections to be made or unmade very quickly. These are obtainable in all the B.A. sizes from 0 to 5 at about double the price of milled nuts. Where terminals are needed which do not protrude below the under-



The type and size of aerial insulators used in constructing the Rugby station aerial is clearly demonstrated in this photograph.

WORKSHOP HINTS—continued

surface of the ebonite, as in valve holders and other small components for panel mounting, it is a good tip to make one's own, using screws with countersunk heads for the stems. Small round nuts in all the B.A. sizes can be purchased very cheaply from tool shops, and with these and either milled or wing-nuts for the tops neat terminals can be made.

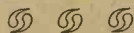

ILL-FITTING SCREWS AND NUTS

HOW often, when one is forced by lack of time to obtain supplies of B.A. screws and nuts from "the little shop round the corner," does one find either that the nuts are a



Having had the pleasure of listening to John Henry and Blossom "over the wire"less" we shall shortly be seeing them on the films.

trifle too small or the screws slightly too large? The nut goes on quite easily for the first two or three turns and then refuses to go any farther. And, unfortunately, it is not only the small shop whose owner dabbles in the sale of wireless fittings that plays this unkind trick upon the constructor.

Just the other day I obtained from a big wireless firm a dozen clips supplied with screws and nuts for fixing purposes. Only two of the nuts would go on the screws. I must say that the firm was most apologetic about it and sent a fresh supply directly I called their attention to the matter; but, as is usually the case, I tackled the job of mounting those clips at a time when no shops were open, so that it was impossible to obtain other screws and nuts; nor had I in my stock any of the required size that were of the proper length.

The First Thing to Do

When this kind of thing occurs the first thing to discover is whether it is the nuts that are too tight or the screws that are too big. This can be done by running one of the nuts on to a standard tap of the proper size. If the nut goes on quite easily, then the screws are at fault, but if force is required to put the nut on and if the tap is obviously cutting, the screws are not to blame. When the nuts are too tight it is not a long job to deal with a dozen or two of them. Fix the tap in the chuck of your hand drill and run the first nut to be tackled a little way on to it with the fingers. Then grip the nut in the jaws of the vice and run the tap through quite fast. Having withdrawn the tap, put the nut into an empty cigarette tin and go on with the next.

Quick Work

Working in this way one can easily deal with a dozen tight nuts in five minutes. If it is the screws that are slightly too big, fix a die of the proper size into the jaws of the vice and run the screws through it one by one. Should you possess a spiral ratchet screwdriver, the job is very easily and quickly done.

IT'S THE LITTLE THINGS THAT COUNT

MANY beginners at constructional work find it rather difficult to punch-mark a panel accurately as a preliminary to drilling. Even if the marking out has been done with considerable care and accuracy many of the centres do not lie, as they should, at the junction of the cross lines made with the scriber. One of the commonest causes of inexact centre punching is to be found in the use of a tool that is unsuitable for the purpose. For wireless work, where most of the holes are made with small drills, the best type of punch is one that tapers gently to a fine point. The more or less round-pointed punch with a steep taper is not at all what is wanted.

The Punch to Use

When the point is sharp one can feel the way into the scratches made by the scriber and arrive at the exact point of intersection of the cross lines. It is a good tip to keep your centre punches always sharply pointed. This can be done without difficulty by the use of a keen medium file. Even when you have to make a 1/4-inch or 3/8-inch hole in a panel, it is better to mark the drilling centre with a fine pointed centre punch.

Capacity scooped out—

That is what we have done to this new LISSEN VALVE HOLDER—in every conceivable place capacity and loss have been literally scooped out. This new LISSEN VALVE HOLDER should find a place in all efficient receivers, particularly those working on the low wave-lengths. (Patent pending.)



Price 1/8

Springs can be bent back for base-board use.

Daylight in a coil mount—



Price 1/-

Instead of capacity and loss there is daylight in the new Lissen Coil-Mount—the mount which is now being fitted to all LISSENAGON coils. You can buy this new Lissen Coil-Mount separately—fit it to your existing coils, or any coils you wind yourself.

LISSEN

LISSEN LIMITED,
 26-30, Friars Lane,
 Richmond, Surrey

Managing Director: Thomas N. Cole.

AN ALL-PURPOSE VALVE UNIT

By L. H. THOMAS (6QB)

Constructional details of a useful addition to the experimenter's equipment

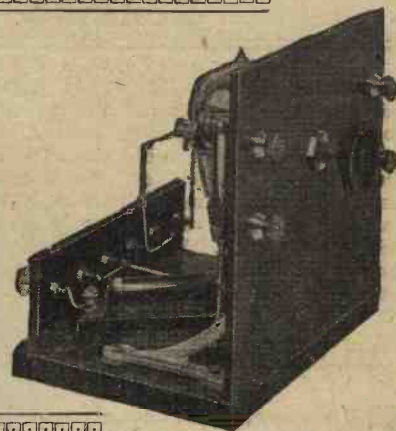

ALTHOUGH most of us agree that it is always preferable, in wireless, to keep one piece of apparatus for one particular job, and not to attempt to use it for anything else, it sometimes entails a considerable strain on the experimenter's pocket to follow this rule. It is, in many cases, quite practicable to construct a unit in such a manner that it may be used for a large number of different experiments without having to undergo any alteration itself, all the changes being made in the

ment can be used for quite a number of purposes without undue clumsiness and complicated switching (the usual objection to "multi-purpose" gadgets), and at the same time without loss of efficiency.

Of Utilitarian Value

It was originally used as a low-frequency amplifier, employing the resistance-capacity method of coupling, and was employed in connection with some tests carried out on the lower wavelength broadcast band. The

amplifier, this method of coupling being, of course, quite efficient on wavelengths of that order.

In addition to these two purposes, it may also be used as a detector following a stage of resistance-coupled high-frequency amplification, or even as a straight single-valve receiver, if suitable coils and a variable condenser are brought into commission externally.

The Circuit Explained

The circuit of the unit itself is shown in Fig. 1, from which it will be seen that two terminals for grid bias are provided. Normally these are only used when the unit is employed as a low-frequency amplifier. Also, both the resistances and the condenser are of the "clip-in" variety, so that the flexibility of the instrument is further increased.

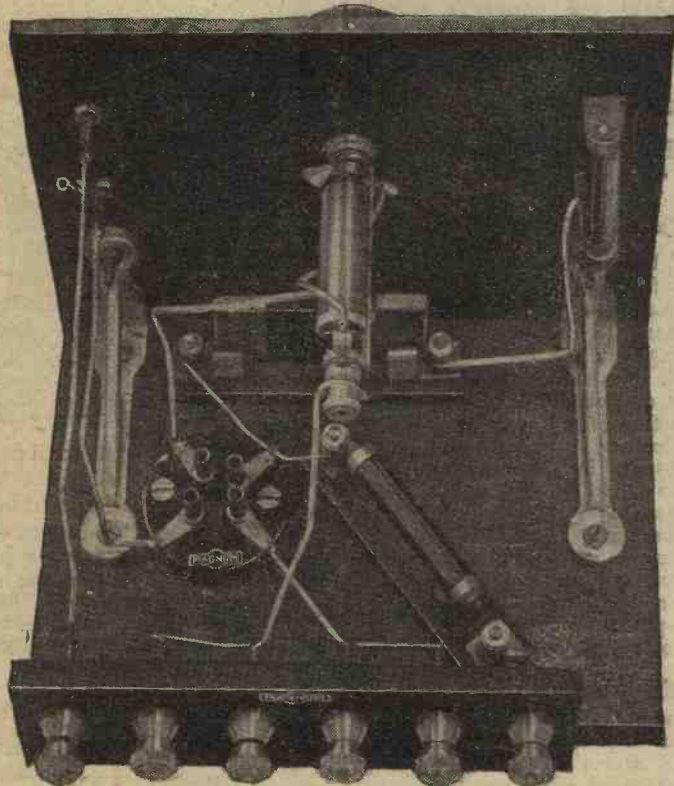

The anode resistance R_3 is mounted directly behind the "input" terminals.

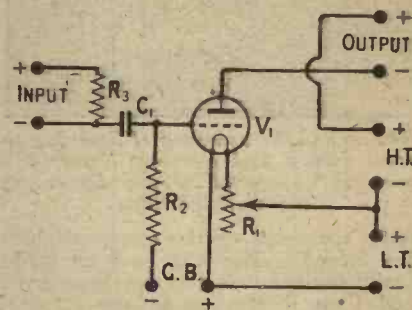

Fig. 1.— R_2 , R_3 and C_1 are all of the "clip-in" variety.

arrangement of the circuit outside the unit.

The writer has made the useful unit described in this article to show that one small and inexpensive instru-

writer then had occasion to repeat these tests upon wavelengths around that of Daventry, and the idea struck him that the same unit might then be used as a resistance-coupled H.F.

Only one high-tension positive terminal is provided, that being used for the potential applied to the anode of the valve in the unit itself. Since the "Input" terminals on the left of the panel are connected to the telephone terminals of the receiver to which it is being attached (all these remarks applying, of course, only when it is used as a low-frequency amplifier), the high-tension on the anode of the last valve in the receiver, whether it is the detector or a note magnifier, will not be interfered with. Care must be taken to connect the input terminals correctly. The positive (upper) one should be connected to the

AN ALL-PURPOSE VALVE UNIT—continued.

telephone terminal on the receiver which goes to the high-tension positive.

Construction of the Amplifier

As will be seen from the photographs and the back-of-panel diagram, both the initial construction and the wiring are very simple indeed. The only component mounted on the panel is the filament rheostat (the anode resistance being secured in clips attached directly to the input terminals). Behind, on the baseboard,

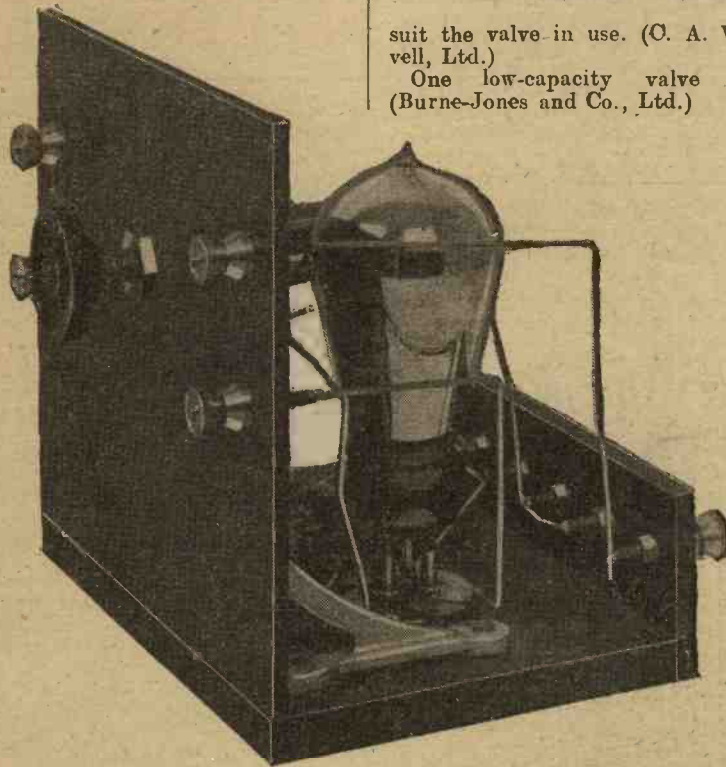

Only the input and output terminals and the filament rheostat are mounted on the panel.

are the valve-holder, the grid-leak and condenser, and the terminals for the three batteries. The wiring is extremely short throughout, and was carried out with square tinned copper wire.

The Components Used

For the guidance of readers who wish to construct an exact duplicate of the amplifier shown in the photographs, the following list of the components used is given. It will, of course, be understood that the actual makes need not be strictly adhered to, provided that the dimensions and values are not altered.

- One Radion panel, 6 in. by 7 in. (American Hard Rubber Co.)
- One baseboard, 7 in. by 4 1/4 in. (Carrington Manufacturing Co., Ltd.)
- One filament rheostat of resistance to

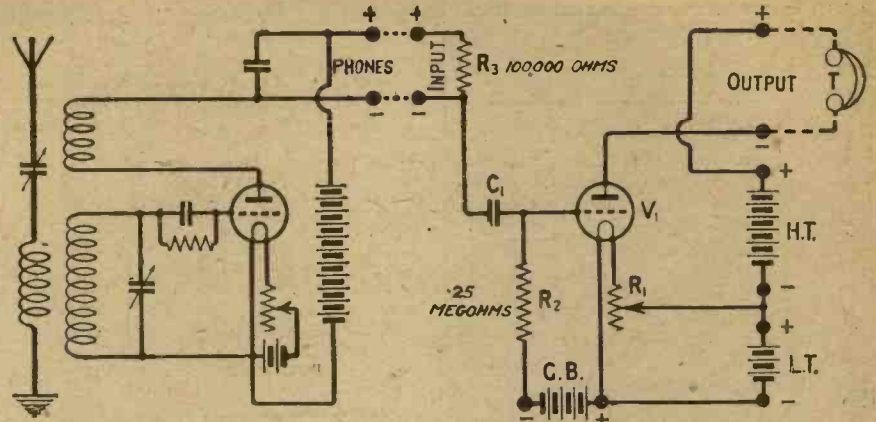

Fig. 2.—The necessary connections for using the unit as a low-frequency amplifier. Separate batteries are shown for clearness.

- suit the valve in use. (O. A. Vandervell, Ltd.)
- One low-capacity valve holder. (Burne-Jones and Co., Ltd.)

- One .0003 clip-in condenser.
- One .01 clip-in condenser.
- One .25-megohm grid-leak.
- One 2-megohm grid-leak and one 100,000 ohm resistance, with necessary bases, and one condenser base (L. McMichael, Ltd.).
- One ebonite strip, to take six terminals.
- Ten brass terminals.
- Two small panel brackets.
- Sundry wood-screws, tinned copper wire, etc.

As a Low-Frequency Amplifier

A study of Fig. 2 will make quite clear the method of connecting this unit in circuit as a low-frequency amplifier. For this purpose the value of the anode resistance (across the input terminals) should be about 100,000 ohms; the grid condenser should have a capacity of .01, and the grid-leak should be .25 or .5 megohm. The necessary values must, of course, be modified in the list of components should the reader wish to depart from them. Since the leaks and condensers are easily interchangeable, this may be done without any trouble.

Suggested Voltage Values

The bottom end of the grid-leak, in the unit, is connected to the negative grid-bias terminal, and this should

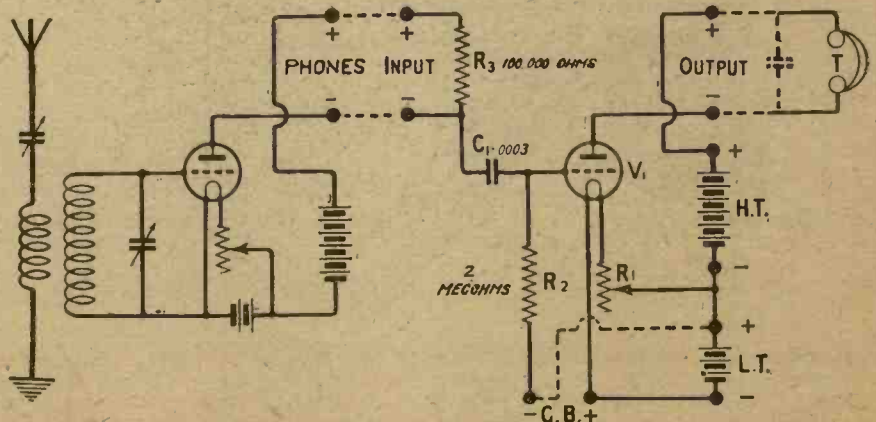

Fig. 3.—When the unit is employed as a detector, a by-pass condenser must be connected across the telephones.

AN ALL-PURPOSE VALVE UNIT—continued.

accordingly be connected to the negative end of the grid-bias battery. (This seemingly obvious fact is mentioned because when the unit is employed for other purposes this terminal is connected in quite a different manner). If the amplifier is being used directly after a detector, about 90-120 volts high-tension with $4\frac{1}{2}$ - $7\frac{1}{2}$ volts negative grid-bias are recommended. If, however, it is in use as a second stage of amplification about 9 or 12 volts grid-bias will be advisable, while the high-tension may be anything up to 180 volts.

Desirable Features

When used in this manner the chief feature lies in the very pleasing purity of reproduction, although the amount of amplification usually associated with a good transformer ampli-

fier will not be obtained. Best results are secured when the valve in the

.0003 condenser and a 2-megohm leak, or components with similar values,

Fig. 4.—No difficulty will be experienced in the drilling of the panel. (Blueprint No. C 1053 a.)

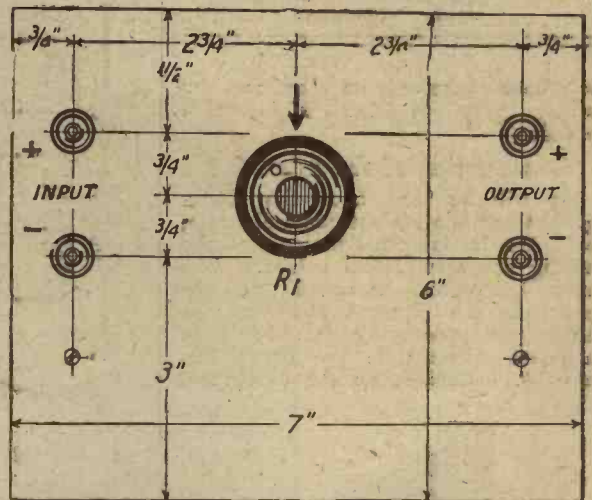

anode circuit in which the 100,000 ohm resistance is inserted (i.e., the detector or preceding note-magnifier to this unit) is one of the high-impedance type specially designed for resistance amplification (e.g., the D.E. 5b type).

The high-tension voltage on the preceding valve will also probably have to be increased somewhat to compensate for the voltage drop across this resistance. It is assumed that a by-pass condenser is always used across the 'phones, if the latter are directly in the anode-circuit of the detector; this condenser will then automatically be connected across the resistance, which takes the place of the 'phones.

should therefore be substituted for those in use. To ensure proper rectification the bottom end of the grid-leak must now be connected to the positive L.T. terminal, i.e., the negative grid-bias plug should be removed from its battery and connected to the positive low-tension terminal. The unit may now be used after a stage of resistance-coupled high-frequency amplification without further alteration. Fig. 3 shows the complete arrangement, which will be found very suitable for the reception of 5XX and other long-wave stations. (The resistance-coupled H.F. arrangement is not, of course, very efficient below 1,000 or 1,200 metres.)

A Possible Refinement

The 'phones are now simply connected to the output terminals, the H.T. voltage applied to the anode of the valve in the unit (now the detector) being suitably modified. About 45 volts will probably give the best results. The high-tension on the H.F. amplifier will not need to be more than about 70 volts.

As a refinement, a variable grid-leak can easily be plugged into the holder for fixed resistances, if desired, but as the unit will probably not be used so often as a detector as for a note-magnifier, this was not done in the original instrument.

Further Applications

It will be seen from Fig. 3 that very little alteration is needed to convert the unit into a second stage of high-frequency amplification, after a resistance-coupled stage. The end of the grid-leak (i.e., the G.B. terminal) may be connected either to the L.T. terminal or to the moving contact on a potentiometer, and in the anode circuit of the valve in the unit may be inserted either a tuned circuit or the primary of a high-frequency transformer, or, if desired, another anode resistance. It may be used for any of the well-known methods of H.F. coupling.

Detector Modifications

Let us now consider the means of using this unit as a detector. In the first place, the grid-leak and condenser will obviously need to be altered. A

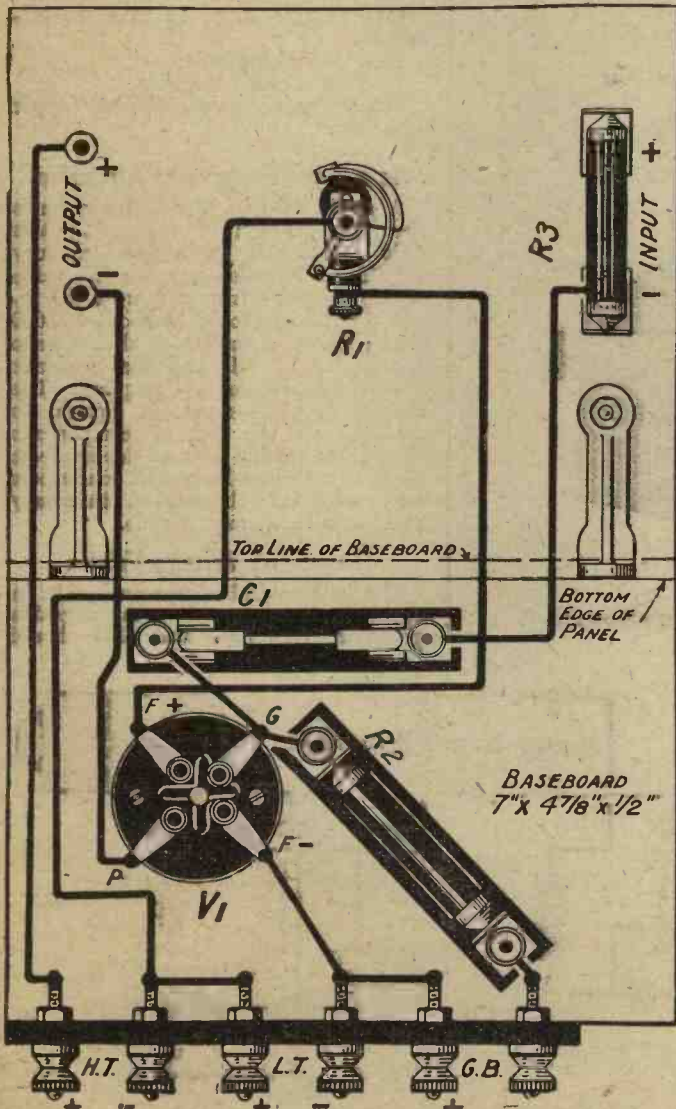
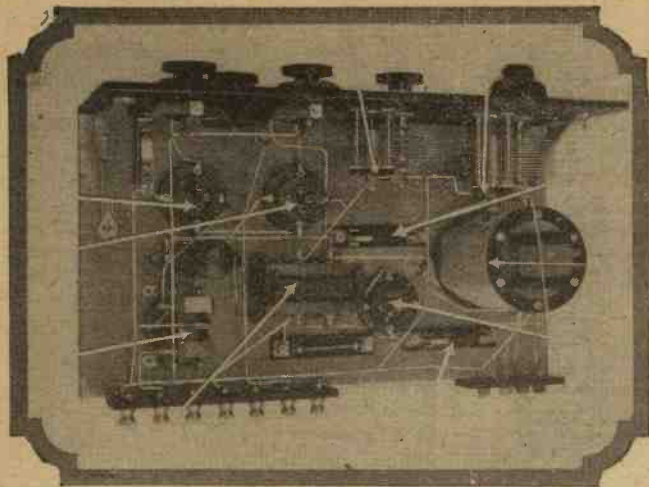

Fig. 5.—The small amount of wire used is apparent from this diagram. (Blueprint No. C 1053 b.)



WHERE INSULATION MATTERS

By C. P. ALLINSON, A.M.I.R.E.

Good insulation is vital in certain places, but is not so important in others. This article shows just where trouble must be taken.

A LARGE quantity of insulating material such as ebonite, bakelite, mica and sometimes porcelain or pyrex glass is used in the construction of a wireless receiver and its component parts, and one may be inclined to wonder at times whether this is all necessary. Might it not be possible to construct a set without taking all this meticulous care about the insulation, and yet not impair its efficiency?

The answer in nine cases out of ten is "No."

A Wooden Panel

There is certainly one part of the receiver where ebonite or bakelite can be eliminated, providing always that a suitable circuit is used, and that is

In certain parts of the receiver, however, insulation is most vital. If only slightly impaired a marked loss in efficiency often results, and in certain cases, which will be dealt with in due course, not only may a reduction in signal strength be caused but the quality of reproduction is spoilt.

A Typical Circuit

Suppose we have a receiver employing a circuit such as that shown in Fig. 1. This consists of a detector valve, followed by three stages of resistance-capacity low-frequency amplification. Now, how will quality be affected by poor insulation, and at what points is this question of insulation likely to be critical?

high value of H.T. voltage, and even if valves specially designed for the purpose are used 100 volts is needed. Now, suppose that the insulation of the coupling condenser C_1 is faulty, the effect of this is equivalent to shunting it with a resistance which is shown dotted as R_{12} . It will be appreciated that this results in a positive potential being applied from the high-tension battery to the grid of V_2 . This will result in grid current passing, in fact it will act similarly to grid-condenser rectification in the case of a detector valve. Distortion is therefore introduced, and the purity of tone generally associated with resistance-capacity amplification will be spoilt.

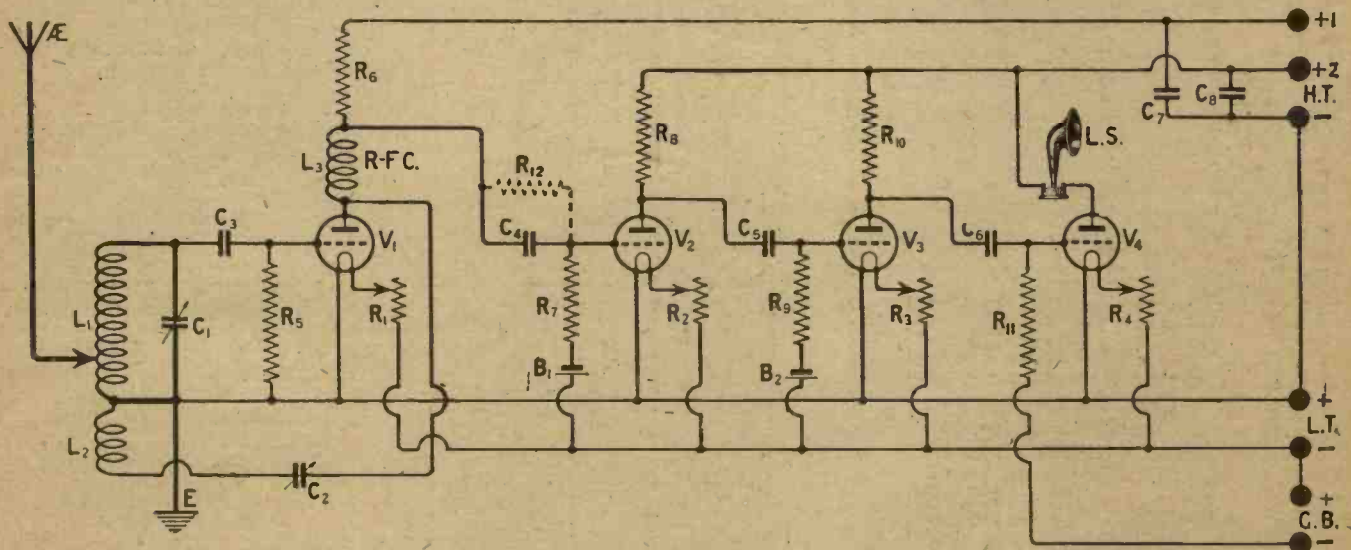

Fig. 1.—This circuit, which usually gives very pure reproduction, may be entirely spoilt if the condenser C_4 is leaky.

the panel on which the controls are mounted. In such receivers as the "Elstree Six" (see *Modern Wireless*, June and July issues), where all metal parts coming in contact with the panel are at earth potential as regards H.F. currents, wood or some similar substance may be used for the panel.

It will be seen from the diagram that fixed condensers C_4 , C_5 , and C_6 are used to couple the anodes and grids of succeeding valves. Thus, C_4 couples the anode of V_1 to the grid of V_2 and so on.

As is no doubt known to most experimenters, a resistance-capacity coupled amplifier requires a rather

The Effects of Grid Bias

If a small biasing battery is used, as shown in the circuit at B_1 , to apply a negative potential to the grid the effect will not be so serious; nevertheless it will be present. In the case where a D.E.5b type valve is employed only about $1\frac{1}{2}$ volts negative

Where Insulation Matters—continued

bias should be used, as an examination of this valve's characteristic curve will show; therefore it will be difficult to compensate for the positive potential applied by the use of a faulty coupling condenser, and such distortion that is thereby introduced, though small, will undoubtedly be noticed by the critical ear.

The same arguments, of course, apply to the other coupling condensers C_1 and C_2 . It is therefore im-

portant to see that these components are of the best quality, and inferior condensers, although cheaper in the first instance, will result in ultimate dissatisfaction.



.....
A portable receiver employing a wooden panel was described by Mr. John Underdown in a recent issue of "Wireless."

Another aspect of the question is that if the grids of the L.F. valves are not kept at the correct negative potential, more anode current will be passed, with a resulting shortening in the life of the H.T. battery.

The Variable Condensers

There are other points, too, at which the insulation is important in the circuit shown. From the point of view of signal strength the tuning condenser C_1 should, of course, be above suspicion. Should this have a low insulation resistance the resultant signals will be reduced in magnitude.

We also have a variable condenser C_2 , which is used for controlling reaction in a manner similar to that employed in the Reinartz circuit. This has to withstand the effective anode voltage, and the presence of poor insulating material will cause a partial short of the H.T. battery; while should dust accumulate between the plates the condenser will become exceedingly

noisy in action, for dust is detrimental to insulation.

Preserving the H.T. Battery

The reservoir condensers C_1 and C_2 must not be forgotten. These are connected across the H.T.appings and therefore have to stand up to the full H.T. voltage of each. The writer experienced a case where three H.T.appings in a set each had a shunting condenser of the usual value of 2

microfarads connected between them and the common negative. With the set switched off a current of .25 milli-amp. was found to be flowing in the H.T. negative lead. Though this is not a heavy current, yet it is sufficient to harm the H.T. battery, since it never gets a complete rest between the periods of working.

watched. The remarks previously made about tuning condensers (which also apply to inductances), apply to the condensers C_1 and C_2 which tune the grid and anode circuits respectively of the valve V_1 . The circuit, which is of the neutralised type, employs the centre-tap grid coil method of stabilisation, and it will be seen that the neutralising condenser shown as N.C. is connected between L.T. - and H.T. + 1 so that should the insulation be poor, a leakage of H.T. current will result.

Although the question of insulation of the grid condenser of the detector valve is always an important one, it becomes doubly so when a stage of tuned anode H.F. precedes the detector. Should the insulation not be perfect a positive potential is applied to the grid, causing not only excessive anode current to flow, but also a loss in rectification efficiency, and therefore a reduction in signal volume.

Transformer Details

If a telephone shunting condenser is used as at C_4 its insulation should be perfect or a reduction in signal strength may result, since part of the signal will flow through the condenser instead of through the 'phones.

In L.F. and H.F. transformers, of course, perfect insulation between windings and also windings and core is absolutely essential. With instruments of repute, however, such faults do not develop often, and although in the case of an L.F. transformer a winding may break down, the other faults seldom appear.

A Relative Matter

"This is all very interesting," I hear someone saying; "but what constitutes good and what bad insulation?"

Well, this is, to a certain extent, a relative matter, and although the ideal to aim at is perfect insulation in all instruments and components, or, as it is usually expressed, the insulation resistance should be infinity, it is not always easily attainable.

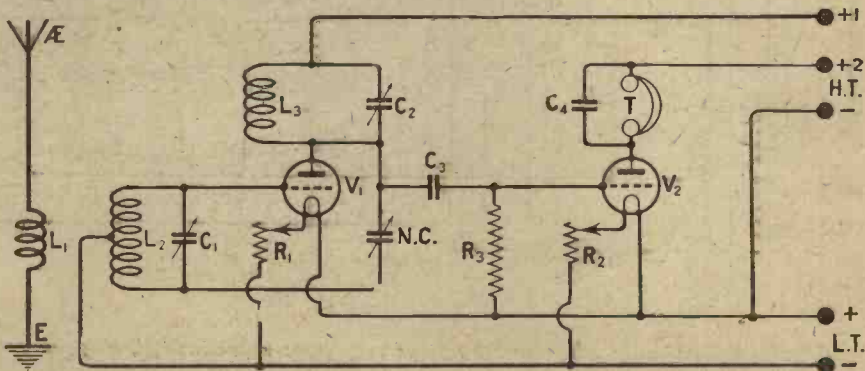

Fig. 2.—In this circuit a faulty neutralising condenser will cause the H.T. battery to run down.

Another circuit is shown in Fig. 2 in which certain points need to be

Another Circuit Analysed

Another circuit is shown in Fig. 2 in which certain points need to be

WHERE INSULATION MATTERS
—continued

It is obvious that in a component such as a filament resistance where the total resistance of the winding is only a matter of thirty ohms or so, the insulation resistance is good enough for general purposes if it is in the neighbourhood of $\frac{1}{2}$ megohm; yet if a condenser showed an insulation resistance of this value it would be accounted as very bad. If the condenser were for shunting telephones, loud-speaker, or L.F. transformer primary it would not be so serious, but if used as a grid condenser it would be fatal.



The famous "Elstree Six" uses a wooden panel.

For a variable condenser, whether used for tuning, neutralising or reaction, the very lowest value permissible in the case of one of the cheaper instruments would be 20 megohms, but a good class component should certainly show not less than infinity.

Uncertain Operation

In the case of valve holders and valve bases again the resistance should not be less than infinity. It is obvious that any fault in the insulation of either of these is bound to result in a serious decrease in efficiency. Not only will the input be reduced by the presence of poor insulation, but the output will also be affected. Also if the insulation is faulty at such points the result may be to make the receiver noisy and uncertain in operation. Since bad insulation is in effect a high resistance, it is liable to vary not only from moment to moment, but also from day to day, a highly unsatisfactory state of affairs.

Testing Apparatus

The difficulty is, of course, for the average experimenter to determine where insulation is good and where bad. The only satisfactory method is to use a megger, but it is only a few who can afford a piece of apparatus of this description. Much can be done with a pair of 'phones and a battery, and their application to various forms of tests have been described from time to time in the pages of THE WIRELESS CONSTRUCTOR, and need not be dealt with again.

For extremely bad insulation a sensitive milliammeter may be used in conjunction with a high voltage battery, so that in such cases an

actual deflection of the meter needle may be obtained.

Clear Away All Dust

One of the chief enemies of good insulation is dust, and it is well worth while spending a little time every week dusting your receiver both inside and out. A round mop brush is a useful means of clearing out the dust, and particular attention should be paid to valve holders, fixed condensers and the like. Variable condensers may be cleaned out with a feather or one of those fluffy wire pipe cleaners.

It is incidentally just as well to keep the top of the H.T. battery free from dust, since otherwise quite considerable leakage may take place.

**A THREE-VALVE
LOUD-SPEAKER RECEIVER**

SIR,—I have constructed the Three-valve Loud-speaker Receiver as described by Mr. J. H. Reyner in the January, 1926, issue of THE WIRELESS CONSTRUCTOR under the heading of

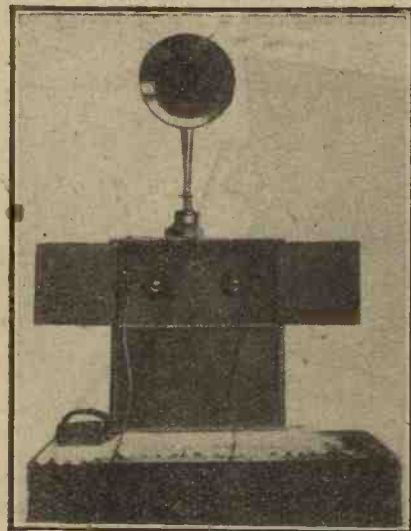

Smooth Reaction Control, and am pleased to say that in every way it is splendid. I enclose a photograph of same, which may be of interest to you.

Yours faithfully,
W. H. PIERSON.

East Ham.

**The Five Fifteen
will call at all stations
if you use**

Cōpex Shielded Coils
(The original interchangeable screened coils.)

MANY attempts have been made, in the past, to deal effectively with the problem of losses due to stray coupling. Now, however, in collaboration with Mr. J. H. Reyner, B.Sc. (the designer of the "Five Fifteen"), we have evolved the Cōpex Coil. This new coil gets right to the root of the interference trouble; the metal screen which covers the coil definitely eliminates all interaction



Prices: Unit and base ... 15/-
(Patent applied for.)
H.F. Transformer for the Five Fifteen (B.B.C. Wavelength) 7/6
Particulars and prices of other Cōpex Coils and Transformers on application.

Build the PILOT Way!

We guarantee good results.

Using Cōpex Coils, the Five Fifteen (described in the last issue of this journal) is remarkably stable, and exceedingly sensitive and selective. Before building this—or any other set—you cannot do better than follow the lead of thousands of readers and send for the Pilot Manual. This beautifully illustrated book tells you about our famous Pilot System of Construction which enables the veriest novice to build a first-class receiver at the cost of the components only. Sixpence in stamps will bring you a copy of this book.

- "Pilot" Kit of Components for the Five Fifteen, ... £8 4 6
- "Red Triangle" Ebonite Panel, matted and drilled ... 13/6
- Engraving if required ... 3/6
- Terminal Strip, drilled and engraved ... 1/6
- Polished Mahogany Cabinet with baseboard, ... £2 0 0

IMPORTANT—If you already have some of the parts by you, we will gladly supply any extras you require.

This Month's Set.
The Davio 3-valve Set,
described in this issue.

- "Pilot" Type "B" Kit of Components ... £8 8 6
- "Red Triangle" Panel, 16" x 8" x 1/2" matted and drilled ... 10/6
- Engraving if required ... 3/-
- Price of Polished Mahogany Cabinet and Baseboard will be sent on application.

N.B.—Detailed lists of the two above-mentioned kits of components can be seen at our Branches, or they will be forwarded to you on application.

When a complete kit of parts is ordered, together with the panel, a Marconi Royalty at the rate of 12/6 per valve is payable.

PETO = SCOTT CO., Ltd.

Head Office, Mail Order and Showrooms:
77, CITY ROAD, LONDON, E.C.1.
Branches:—LONDON—62, High Holborn, W.C.1. WALTHAMSTOW—230, Wood Street. PLYMOUTH—4, Bank of England Place. LIVERPOOL—4, Manchester Street.

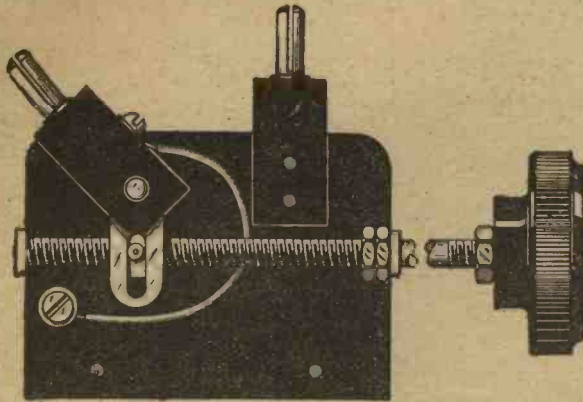

POINTS TO WATCH IN COIL HOLDERS

By H. J. BARTON-CHAPPLE

Wh. Sch., B.Sc. (Hons.), A.C.G.I., D.I.C., A.M.I.E.E.

Some interesting points to be borne in mind when choosing a coil holder

IN order to ensure that a receiving set will function satisfactorily it is of prime importance to make sure that the individual components are of best quality and design. It will be quite obvious to all home constructors that since the market is crowded with apparatus of all descriptions the efficiency of the components will vary to a considerable degree.

Now the term efficiency should be considered in a very wide sense bearing in mind the two prime factors, i.e., soundness both from the mechanical and electrical points of view.

Previous Discussions

Readers will have noticed that during the last month or so various components have been discussed in the columns of this journal, their merits and de-merits being indicated, so that when purchasing the components in question the potential customer is in a position to examine the apparatus with a critical eye.

Displaying Ingenuity

This month it is proposed to deal with coil holders, of which a large variety are available at the present time.

There are, of course, single, two-way and three-way coil holders, and in the last-named two types a great deal of ingenuity has been displayed by manufacturers in order to produce slow-motion effects.

Questions of Surface Leakage

Before particularising it will be apparent that certain qualities are essential to all the types. The quality of the insulating material employed in the manufacture must be of the highest. The surface of the material should be quite smooth, so as to minimise the possibility of globules of water or particles of dust readily adhering and thus causing surface leakage.

If the resistance between the pin and socket is not of the order of several megohms a loss of energy will

take place which may prove very troublesome when weak signals are being received.

Loose Connections

The pin and socket should be accurately mounted, so that the standard makes of coils will fit tightly and securely in place. If a loose fit results then signals will be reduced. In

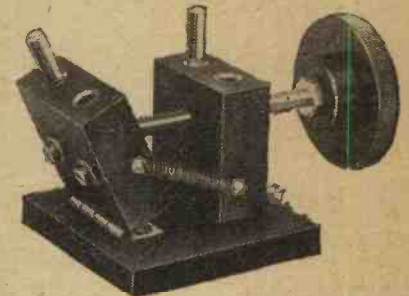

Fig. 1.—A simple but effective type of slow-motion arrangement.

addition, adequate connections must be provided between the pin and socket, and the terminals or screws used for joining to the wiring of the receiver. Faults have often been traced to the failure of the screws to make good electrical contact due, in many cases, to the screws being of insufficient length.

The Addition of Terminal Nuts

The provision of terminal nuts, in addition to soldering tags, is a feature which has much to commend it, as it enables the constructor possessing little skill with the soldering iron to make a proper joint without damaging the holder through overheating with the soldering iron in the effort to make the necessary connections.

A Wide Application

Nothing need be added to the above points when considering the base-board - mounting single-coil holder and attention must now be turned to the two-way and three-way types which, of course, find their widest application in the variable-magnetic

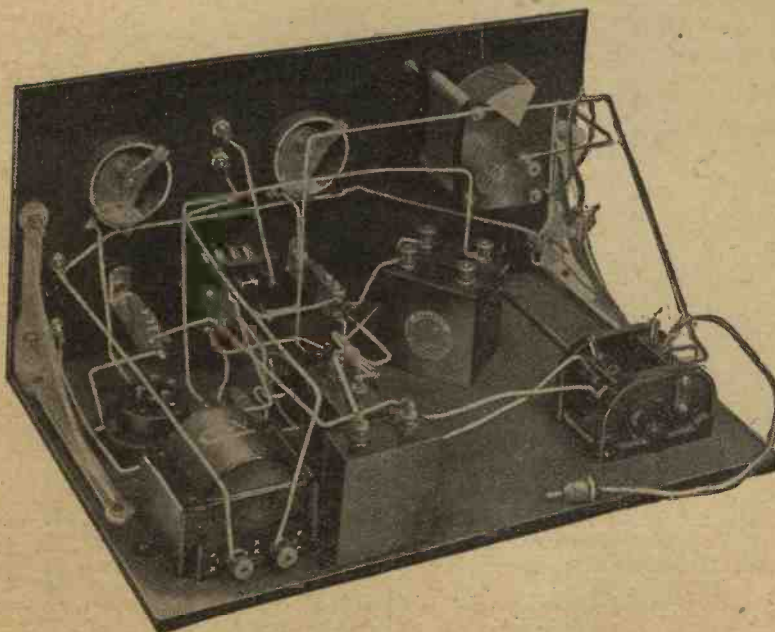

Long extension handles on coil holders are often useful.

**BY FAR THE BEST
YET
MADE**



**VERNIER
RATIO
200-1**

—this is the report of all the Radio authorities to whom we submitted the PYE CONDENSER before placing it on the market.

The same skill and care that have made our scientific instruments world-famous have been brought to bear on this new condenser. The 200-1 vernier movement works as smoothly as the adjustment of a microscope and with the same complete freedom from backlash. The metal work is of solid brass and the insulation of porcelain.



Fixed vanes insulated from end plates by porcelain.

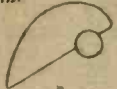

Rotor vanes of decrement shape



Soldered pig-tail connection to rotor vanes

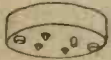

Dust-proof cover for gear mechanism



Definite stops on rotor spindle

CAPACITIES	PRICE
.0001 m.f.d.	: : : £1 2 6
.0002 "	
.0003 "	
.0005 "	
.00075 "	: : : : £1 7 6



VARIABLE CONDENSER
Brings Reception to Perfection

Obtainable from all radio dealers or in case of difficulty from:

W. G. PYE & CO., GRANTA WORKS
MONTAGUE ROAD, CAMBRIDGE
Manufacturers of Scientific Instruments & Radio Apparatus

Figures to Remember



The Innkeeper

To the weary traveller this one-time familiar figure stood for real comfort and the best of good things. To the wireless enthusiast to-day, Six-Sixty Valves stand for the best in radio reception. They enable you to command unequalled volume, and yet retain that wonderful purity of tone for which they have already become famous. And it's good to know that our new range contains just the valve you need for your particular set or circuit.



S.S.7

Voltage 37 volts
Consumption 1 amp.

PRICE 22/6

Take for instance the S.S.7—a real Power Valve which has been recommended by all the leading Wireless Journals to-day. This valve is absolutely non-microphonic, and consumes only 1 amp. filament current. Hundreds of satisfied users have expressed their appreciation of this perfect valve, emphasising in the main its wonderful purity of tone and remarkable economy. We can confidently state that there is no valve on the market to-day which can boast of a longer life, because there is no valve that operates at a lower temperature.

Then, there's the S.S.3 L.F. (green disc) for small or medium-sized Loud Speakers. The S.S.3 (red disc) gives excellent results both as an H.F. amplifier and as a detector. Owing to the low current consumption of both types, dry cells may be used.

*For PERFECTION OF QUALITY
insist on SIX-SIXTY VALVES.*

*Leaflet S.S. 1.7
gives full particulars.
Your Dealer
will be pleased to
order Six - Sixty
Valves for you if
he is out of stock.*



SIX-SIXTY VALVES
Better by Six times Sixty

The Electron Co., Ltd., Triumph House, 189, Regent Street, London, W.1

Points to Watch in Coil holders—continued

reaction circuits that are still popular with a large number of constructors.

An Important Point

To generalise again it is essential that the moving coil block should be

so as to avoid the magnetic field produced by the coil linking this metal and causing losses. When extension handles are incorporated to enable the coil holder to be mounted on the base-board, away from the other compo-

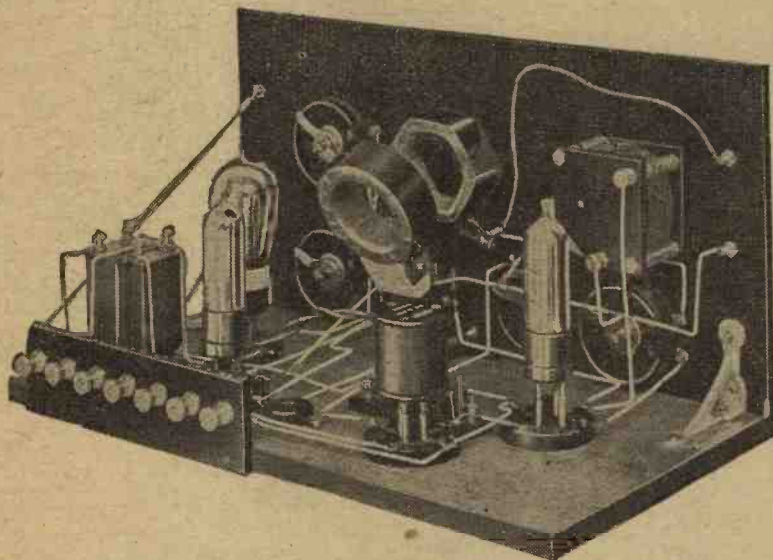

This type of coil holder is often useful.

capable of remaining absolutely steady in any position between its limits of travel. The heaviest of plug-in coils should not be capable of causing the block to fall or, of course, the whole purpose of the coil holder is defeated.

The Moving Block

Many spring devices have been incorporated into the holders in order to bring about this most desirable state of affairs, and the heading illustration shows one particular make which incorporates a moving block pivoted by means of a small pin.

Turning the knob makes a collar travel along a screwed thread, the collar engaging in an arm with a slot and moving the coil block against the tension of a spring. Figure 1 shows another arrangement, the moving block being hinged at its base, the forward travel of a screwed rod pushing the block round and altering the tension of a helical spring mounted at the side.

Avoiding Backlash

In many types special gearing is employed to give a slow motion effect as an aid to fine tuning, and in these cases a complete absence of backlash is desirable for smooth working. If backlash is present the operation of the receiver becomes erratic, and sudden bursts into oscillation take place which, of course, are particularly objectionable.

A Minimum of Metal

The minimum of metal should be present in the completed component

nents, hand capacity effects are often present. This may prove troublesome in a very sensitive receiver, and should be guarded against wherever possible.

.....
Coil holders mounted in this manner are useful for experimental work.
.....

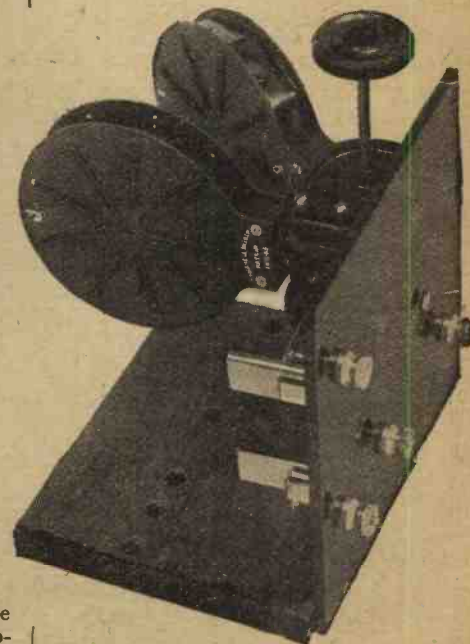

Conclusion

When designed for mounting at the back of the panel, as in the photograph above, ensure that the holding nuts are of sufficient size to support the holder when heavy coils are inserted.

If these details are given their due attention little difficulty will be experienced by the wireless enthusiast in deciding on the make which most satisfactorily fulfils his requirements.

A READER'S EXPERIMENT

SIR,—I have read Mr. H. J. Barton-Chapple's interesting article entitled "Crystal or Valve Rectification" in the June, 1926, issue of THE WIRELESS CONSTRUCTOR, and note he welcomes experiences.

There is one disadvantage of anode current rectification which is often overlooked, and that is the effect of the high valve impedance when working on the bottom bend of the characteristic, and I find that a resistance-capacity amplifier is best after a valve working in this manner.

Some months ago, being pleased with the clarity and selectivity obtained with a single-valve set using the anode current method of rectification, I decided to convert my "Twin-valve Loud-speaker Receiver," described by Mr. John Scott-Taggart in the January, 1925, issue of THE WIRELESS CONSTRUCTOR, from the grid current method of rectification to the anode current, only to discover that, after I had readjusted the circuit to suit, the quality of reproduction was distinctly worse than when the grid leak and condenser method was employed! In spite, therefore, of a great gain in selectivity, I

am reconverting the set back to the leaky grid condenser method.

Incidentally, I am a great admirer of this particular circuit, and have tried one or two experiments of my own with the receiver I have made.

Yours faithfully,
Enstone. E. D. FORESTER.

APPOSITE ADAGES No. 1.

"Well begun is half done"

Specify
DUBILIER
PRODUCTS

Have you entered for the
Dubilicon Competition
yet?
If not, write to us now
for full particulars.
Cash Prize £200.

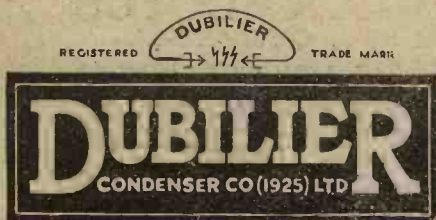

ADVT. OF THE DUBILIER CONDENSER CO. (1925) LTD., DUCON WORKS,
VICTORIA ROAD, N. ACTON, LONDON, W.3. Tel. Chiswick 2241-2-3

E.P.S. 198

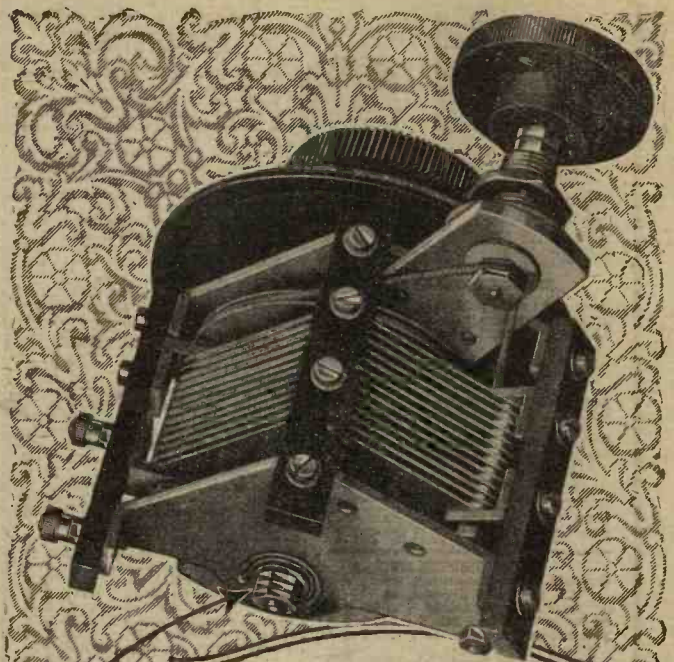

COMPENSATED
SQUARE LAW
EFFECT

LOW LOSS

NO
BACK LASH

**LOW LOSS
SQUARE LAW
SLOW MOTION**

THE "Cosmos" Condenser is a slow motion condenser with absolutely no back lash, either when new or after use. This desirable feature is accomplished by the use of a spring belt held in tension, which permits coarse tuning with the large knob, and a 10:1 slow motion with the small knob.

Cone bearings allow for adjustment and the slow motion bracket can be mounted for remote control as shown in the lower illustration.

The condenser for fine tuning
METRO-VICK SUPPLIES LTD.

(Proprietors: Metropolitan - Vickers
Elec. Co., Ltd.)

METRO-VICK HOUSE,
145, Charing Cross Road,
London, W.C.2

PRICES.

Slow Motion	·0025	mfd	14/8
"	·0005	"	15/6
Ordinary	·0025	"	12/-
"	·0005	"	13/-

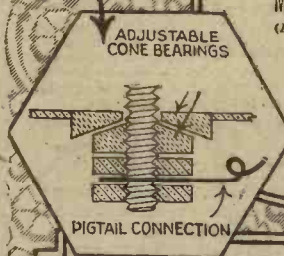

R
P39

COSMOS

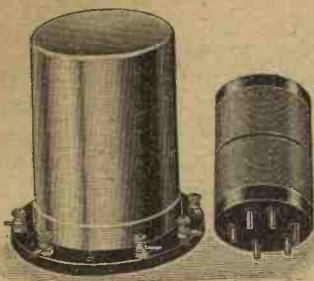

SCREENED COILS.

Developed by Mr. J. H. Renner, and used in the "Magic Five" described in "Wireless," May 29th and June 5th.

	£	s.	d.
Magnum Screening Box complete with 6-pin base mounted on ebonite	15	0	
Aerial Coil, 250/550 metres	4	6	
H.F. Transformer for use with above	7	6	
Complete Set for Magic Five For Daventry Wavelength—	£3	3	0
Aerial Coil	5	6	
H.F. Transformer	10	0	

Use MAGNUM RESISTORS for the ELSTREE SIX.

THE ELSTREE SIX.

Complete set of Components for this wonderful Receiver, as specified by the Author	26	0	0
Or Ready Wired and Tested	29	0	0
Plus Marconi Royalties	3	15	0

Send stamp for Latest Lists dealing with 15 Radio Press Sets, and New Illustrated Catalogues.

Note.—Where a complete set of components, together with a drilled panel, is purchased, Royalties at the rate of 12/6 per valve holder are payable.

BURNE-JONES & CO., Ltd.

Manufacturing Radio Engineers,
Magnum House, 296, Borough High Street, London, S.E.1
Telephone: Hop 6237. Telegrams: "Burjomag, Sedist, London."
Cables: "Burjomag, London."

A New Magnum Product. RESISTORS.

Supplied in ranges to suit all types of valves.

Note.—Owing to the numerous types of valves operating on different voltages it is advisable when ordering to state make and type of Valve used and Voltage of Accumulator. When building your next Set specify MAGNUM RESISTORS. They eliminate unsightly knobs, ensure correct filament temperature and prevent over-running Resistor on base as illustrated. 2 6 Resistor only without base, all values 1 9 Shorting Plug 1 0

Construct the DAVLOW THREE

AS DESCRIBED IN THIS ISSUE.

	£	s.	d.
1 Cabinet	2	10	0
1 Ebonite Panel, 16 x 8 x 1/4 in.	0	10	0
1 Cleartron Diakast Condenser .0005	0	14	6
1 Dial for above	0	2	6
1 Jackson Variable Condenser .0003	0	9	0
1 Pacert L.F. Transformer, 1st stage	1	7	0
1 H.F. Choke	0	10	0
1 Varley Anode Resistance, 60,000 ohms	0	7	6
1 Duhittier Fixed Condenser .01	0	4	0
1 Duhittier Fixed Condenser .0003 and 2 meg Grid Leak	0	5	0
1 Duhittier .25 meg Leak and holder	0	2	10
3 Magnum Fixed Resistors	0	7	6
3 Vibratory Valve Holders	0	8	6
1 Igranic On-Off Switch	0	2	6
1 Double Circuit Jack	0	2	6
1 Etasca 2 pole C.O. switch	0	8	0
1 Filament Switching Jack	0	2	3
1 Terminal Strip, 3 in. x 1/4 in., with 2 Terminals	0	1	0
2 Ebonite Tubes as described	0	3	0
Wire for winding above	0	1	6
Glazite Wire and Flex	0	2	0
1 Packet Radio Press Transfers	0	0	6
	29	0	0

—make your H.F. worth while

TRIX Variable H.F. Transformer, as illustrated, 300 to 3,000 metres, plug-in type, efficient, compact and economical, No. 37 .. 17/6 Type B for panel mounting, No. 250 .. 19/6 Barrel type H.F. Transformers, all wavelengths, No. 255 .. 7/- each Best quality cut ebonite throughout.

TRIX Anode inductance with eight tappings, one hole panel mounting, 300 to 3,000 metres, No. 249 .. 18/6 Anode inductance with reaction, providing smooth reaction over the whole range, No. 251 .. 31/6 Both above have white ivory engraved dials.

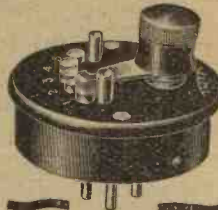

Manufactured by
ERIC J. LEVER,
33, Clerkenwell Ga.,
London, E.C.1.

Branches:
Birmingham, Liver-
pool, Halifax, G'gow,
Treadlaw, Glam.



The NEUTROVERNIA DIRECT-READING DIAL

All purchasers of the Gambrell Neutrovernica Condenser can now obtain an indicating dial which will enable instant return to be made to settings previously logged. The dial is attachable to the condenser—No further panel drilling is required. Price 1/8, Postage 2d.

Bracket for mounting the Neutrovernica Condenser behind the panel Price 4d.

Full particulars of the Dial and other Gambrell productions can be obtained from:—

GAMBRELL BROTHERS, L^{TD},
76, VICTORIA STREET, LONDON, S.W.1.

No unnecessary handling with the "Lotus"

Moving block cannot fall.

The fewer adjustments, the easier it is to get accuracy. The "Lotus" is designed and proved in actual tests to respond to the most delicate operation without the exasperation caused by ordinary coil holders. The moving block remains rigidly in position with the heaviest coil and no screws are needed to tighten it. It also moves in the same direction as the knob, which prevents any confusion. Three sets of enclosed precision machine cut gears ensure this.

LOTUS VERNIER COIL HOLDERS

From all Radio Dealers.

Two Types:
For outside panel mounting:
Two-way ... 7/-
Three-way ... 10/6
For inside baseboard mounting, with 6 in. handle:
Two-way ... 8/-
Three-way ... 12/6

Garnett, Whiteley & Co., Ltd.,
Lotus Works, Broadgreen Road, Liverpool.
Makers of the new improved "LOTUS" Valve-Holder.

Bakelite mouldings for the side plates, coil blocks and knobs; heavy nickel plating for the metal parts.



One Rheostat for both dull & bright emitter valves!

The "PEERLESS" DUAL RHEOSTAT

3/9

From Dealers or direct Trade Terms on request.

The **BEDFORD ELECTRICAL & RADIO Co., Ltd.**
22, Campbell Road, Bedford.

Made specially to meet demand for a rheostat covering needs of both bright and dull emitter valves. Two windings, one of a resistance of 6 ohms, and a continuation of this on to a 30 ohm strip winding. Resistance wire wound on hard fibre strip under great tension and immune from damage. One-hole fixing, terminals conveniently placed. Contact arm has smooth, silky action. All metal parts nickel-plated. Complete with ebonite combined knob and dial.

RADIAX COILS FOR HOME CONSTRUCTORS.

RADIAX DX COILS increase selectivity 100 per cent.

Give an auto-coupled tuning circuit without altering your set. You will cut out the local, or separate two difficult stations to an extent undreamed of. 5 terminals make it a Universal coil. To introduce, a free chart will be given with each purchase, showing the many circuits in which this coil can be used—Auto-Coupled, Neutrodyne, etc.

No. 35, 4/6. No. 50, 5/- No. 75, 5/6.
No. 150, 7/6. Set of 4, 21/- Postage extra.

Radiax Low Loss Coils

give you improved tuning volume and selectivity

No. 25 .. 1/3 No. 75 .. 2/- No. 200 .. 4/3
" 35 .. 1/3 " 100 .. 2/3 " 250 .. 4/9
" 50 .. 1/9 " 150 .. 2/9 " 300 .. 5/3

Complete Catalogue of Sets and Accessories, 3d. stamps.

RADIAX LTD., 44, Accessory House, Palmer Place, Holloway, London, N.7.





For "The Wireless Constructor" at our Elstree Laboratories.

Combined Wavetramp and Filter

WE have received from Messrs. Claude Lyons, British Agents for the General Radio Co. of America, a combined wavetramp and filter.

This instrument comprises a small geared condenser to the terminals of which a special coil is connected. This coil is provided with two windings, one of which is tuned by the condenser, and the other of which acts as a coupling winding and is tapped with a small switch. The aerial circuit is connected to the coupling winding, which may either be arranged as a series part coupled rejector, or as an acceptor circuit shunted across the receiver.

The condenser is calibrated in wavelengths when used with the appropriate coil, and on test this calibration was found to be accurate over the whole of the range. When employed as a wavetramp, it was found to assist the selectivity to a considerable extent, although it was not quite as good as the tapped auto-coupled arrangement which is very commonly employed. The instrument is very well constructed and attractively finished. The calibration of the condenser scale renders the device particularly suitable as an absorption wavemeter (one of the purposes for which it is intended), while the trapping action is quite up to standard. We can thoroughly recommend this component for use.

Automatic Rheostats

A COMPONENT received from Messrs. Rothermels is the "Amperite," described as the self-adjusting rheostat.

These components are similar to a

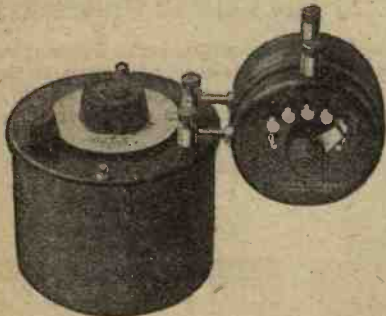

The combined wavetramp and filter submitted by Messrs. Claude Lyons, British Agents for the General Radio Co. of America.

gridleak or anode resistance in appearance, consisting of a cartridge surrounded with black paper and lettered in gold, with two metal cone ends which fit into clips, the whole



The "Amperite" is similar to a grid leak or anode resistance in appearance.

being mounted on a small strip of ebonite; both nuts and soldering tags are included for making connections. They are neatly boxed in black and yellow cartons, but it would appear to be advantageous if these could be printed giving particulars of which "Amperite" is suitable for the English valves.

The cartons are marked "For use with a U.V. 199 and C. 299," and so on, which are the symbols of the different types of American valves. These are not commonly known in England, therefore the English buyer would probably find difficulty in selecting the correct "Amperite" for his own use.

Grid Leak

MESSRS. EDISON SWAN ELECTRIC CO., LTD., have submitted to us for test and report two of their grid leaks.

These are of the cartridge type with metal end pieces, the leaks being of standard dimensions. Both leaks are rated at 1 megohm, and on test were found to give a value of 1.3 and 1.2 megohms each. The resistance element is contained in an opal glass tube which it is claimed is evacuated, while we understand that their resistance is independent of the applied voltage. When placed on test in a receiver they were found to be satisfactorily silent, and we can recommend these grid leaks for use.

Push Pull Switch

WE have received a "Trix" five-point push pull switch for test and report from Messrs. E. J. Lever. This component is designed for one hole fixing, accomplished by means of

a screwed metal bush. Through this passes a metal spindle carrying three ebonite and two metal bushes. Five spring contacts press against these, and as the spindle is pushed backwards and forwards they alternately make and break contact with the metal bushes, thus enabling various switching arrangements to be employed. The ends of these spring contacts are curved, while two of the ebonite bushes are grooved, thus giving a positive indication of the position of the switch. When placed on test the insulation resistance between adjacent contacts was found to be infinity, while the contact resistance was found to be negligible.

This component is well constructed and neatly finished, and can be recommended for use.

Devicon True Scale Friction Condenser

MESSRS. THE RADIO DEVICES CO., who specialise in the manufacture of condensers, have sent to our Laboratories one of their true scale friction condensers for examination.

The component is fitted with a neat ebonite knob and dial, the condenser being driven through a 2 to 1 gear, while a vernier attachment provides an additional slow motion. No end plate is employed at the top of the condenser, a supporting shoulder piece being utilised instead, thus making the instrument considerably stronger.

By means of the knob a friction disc is rotated, and this in turn rotates the friction wheel, a particularly fine even motion being obtained. There is an extra ebonite support for the two

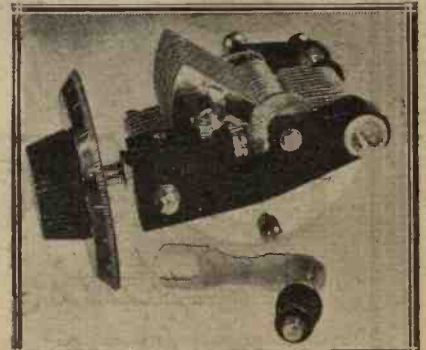

A friction drive is incorporated in this condenser of Messrs. The Radio Devices Co.

Apparatus Tested—continued

terminals, while one hole fixing is provided for.

The rated capacity of the condenser is .0005, but on test it registered a shade under this value.

The introduction of this instrument will certainly meet with the favour of our readers, and we can recommend it for use.

Filament Rheostat

WE have received from King Quality Products, Inc., a sample of their filament rheostat and low-tension switch combined. So far as the resistance element is concerned this is of the conventional type.

The centre spindle carries a circular disc with two metal contacts, these contacts being connected to a centre concentric spindle, the other end of which is joined to a small knob concentric with the main knob. Bearing on this disc is a thin spring contact, which is joined to a third terminal on the body of the rheostat. The insulating disc previously mentioned has two depressions for "off" positions.

The contact arm is well shaped and tempered, and is stamped in such a way as to give it an inherent springiness. The whole component is of a very high degree of workmanship, both the construction and finish being

exceptionally good. The movement of the contact finger of the resistance element is also noticeably smooth.

Balancing Condenser

MESSRS. THE IGRANIC ELECTRIC CO., LTD., have sent us one of their vernier balancing con-



Showing the construction of the combined filament rheostat and L.T. switch received from King Quality Products, Inc.

densers for test and report. This component is intended for use where dual condensers are used to tune two separate circuits, in that it affords a

method of compensating any inequality either in the two halves of the dual condenser or in the two inductances that are being used.

The component consists of two sets of fixed plates mounted opposite to each other, while a set of moving vanes may be interleaved with either set of fixed vanes, a maximum capacity of 14 micro-microfarads being obtainable on either side.

On test the insulation resistance between the moving plates and the fixed, and the one set of fixed plates and the other set was found to be infinity in each case.

This instrument is well made, pleasing in finish, and can be recommended where a balancing condenser is required.

Cosmos Variable Condensers

MESSRS. METRO-VICK SUPPLIES, LTD., have sent us two of their variable condensers for test and report. Both condensers are of the square-law pattern, and are constructed on low-loss lines. The moving vanes are grounded to the end plates, and connection is made to them by means of a pigtail. The dial is 3½ in. in diameter, and is provided with a substantial knob, while a reduction gear of about 12 to 1 is

Use
THE
CLARTONE
Britain's Best
FROM ALL RADIO DEALERS

ARTCRAFT
Cabinets "Popular Type"

Oak or Mahogany Cabinets of Artcraft design and construction are a credit to the set you build

Sizes of "Artcraft Popular Type" Cabinets

Panel Size	Depth	Price in Oak	Price in Mahog.
9 x 6	6 x 6	6/0	10/0
10 x 8	8 x 6	8/0	12/0
12 x 10	8 x 8	12/0	16/0
14 x 10	8 x 8	14/0	19/0
16 x 8	8 x 8	14/0	19/0
18 x 12	9	21/0	29/0

Baseboards Free. Hinged Lids 1/8 extra.
Prices include packing, carriage and insurance to any station in England and Wales. Prompt delivery guaranteed.

Send for Illustrated Brochure

The ARTCRAFT Co.
156, CHERRY ORCHARD RD., CROYDON
Parr's Ad.

Proceed with The Pelican Univernier

The Pelican Univernier is steadily moving on to more panels because it gives to the set owner that nicety of control which is needed to bring in those elusive stations.

Simply take off the dials of your present variable condensers and replace with the "Pelican."

Price 6/-
Guaranteed throughout.

Cahill & Company, Ltd.,
64, Newman St., London, W.1.

Apparatus Tested—continued

obtained by means of two pulleys and a spring belt.

When placed on test the condenser, which has the nominal capacity of .00025 microfarad, was found to have exactly this value, while the other, which was a .0005 microfarad capacity, had an actual value of .00043 microfarad. The insulation resistance of both instruments was found to be infinity, while both are to be recommended for their robust construction and sound design.

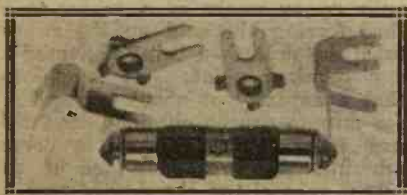

An ingenious spring device allows special clips to be used for mounting the Igranic grid leak.

Grid Leak

A GRID leak has been forwarded to our laboratories by the Igranic Electric Co. for examination and report. This leak, which is of the fixed type, is particularly robust in construction, the resistance of the leak being plainly marked. Conical ends are provided, the leak itself being 2 in. in length, whilst an ingenious spring device under the conical ends allows a special clip to be employed for mounting it.

Two types of clips are provided with the component, one being for panel mounting and the other for soldering the leak in any position. The rated value was marked 2 megohms, and when placed on test it was found to be 2.3 megohms. This component certainly presents a novel and ingenious piece of apparatus, and can be recommended with confidence.

General Radio Low-Loss Coils

WE have received from Messrs. Claude Lyons, the agents for the General Radio Co., of America, a range of low-loss coils. These coils are wound on a 2½-in. diameter Bakelite former, and are wound in two equal sections, the ends being brought out to four screw terminal plates. A bar

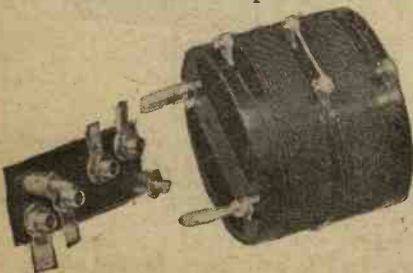

The General Radio low-loss coil submitted by Messrs. Claude Lyons.

across the bottom of the moulding contains four holes, into which pins may be inserted and held by a small nut, and connections are made from these pins to the winding. The four pins fit into a special holder containing four sockets provided with soldering tags.

Since the coils are wound in two equal sections, which may be connected together in the middle by a short strap if so desired, the coils are particularly suitable for the various split coil circuits which have been used to a considerable extent recently. The coils are of reasonably low-loss construction, and gave very satisfactory results when used in a receiver.

"Apex" Crystal

MESSRS. C. O. CLARK have submitted to us one of their "Apex" crystals for test and report. This crystal is packed in a small metal case, being wrapped in cotton-wool, instructions for use being enclosed. In appearance it is of fine

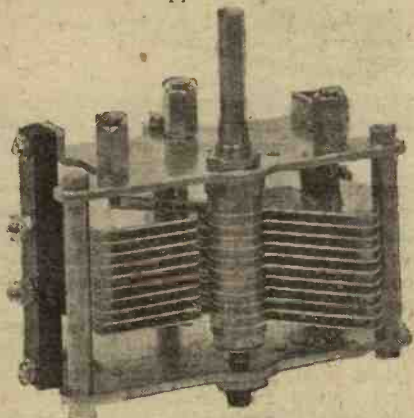

The neat and well-manufactured Cardwell variable condenser.

crystalline structure, of a bluish-grey colour. When placed on test the rectified current obtained from 2LO was found to be slightly below the average. A satisfactory number of spots was found, however, and this crystal can be recommended for general use.

Cardwell Variable Condenser

A NEAT and well-manufactured accessory is to be found in the Cardwell variable condenser which has been sent to our Elstree Laboratories by the Rothermell Radio Corporation of Great Britain.

The plates are manufactured from aluminium, while two ebonite strips insulate the metal frame from the fixed plates, connection being taken from terminal points which are made through the ebonite strip to the fixed and moving plates. The instrument has a very smooth motion, is rigidly constructed, three-hole fixing being provided for.

The rated capacity is .0005, and on test this reading was found to be cor-

rect, whilst the pleasing appearance of the component completes a series of excellent features.

Etherplus Anti-Vibro Valve Holder

THIS valve holder, which is constructed on low-loss principles, is designed for baseboard mounting. The insulating material is placed some distance away from the valve sockets, the sockets themselves being mounted through a rubber base, which is claimed by the manufacturers to be non-



In this Etherplus valve holder the sockets are mounted on a rubber base.

deteriorating. Connections from the sockets to the terminals are made by means of springy strips of metal, this springy action assisting in obtaining the necessary amount of anti-vibratory movement. Soldering tags and terminals are provided.

The component was tested in a receiver and was found to function quite satisfactorily, and damp out microphonic noises to a large extent. When a valve was inserted, it proved a good fit. The manufacturer of this holder is Mandaw, and we can recommend it as a well-designed and mechanically sound component.

Filament Fuse

THE device submitted by Messrs. Phillips is a small fuse for connection in the H.T. circuit where it limits the current to about 30 milliamps. It consists of a thin wire sealed into a small glass tube, with two terminals at the end. Under normal working conditions the drop of the H.T. voltage is very small. If the filament of one valve (or several valves) is accidentally caused to make connection with an H.T. battery, the momentary increase of current causes the wire to fuse before any damage is done to the filament.

We have tested this filament fuse and find that it carries out the claims of the manufacturer. We can recommend it, therefore, to all our readers.

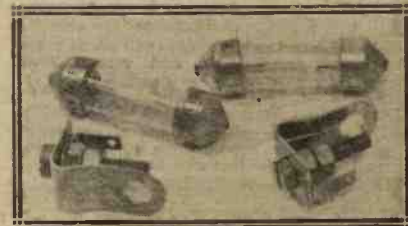

Damage to valve filaments is prevented with this Phillips fuse.

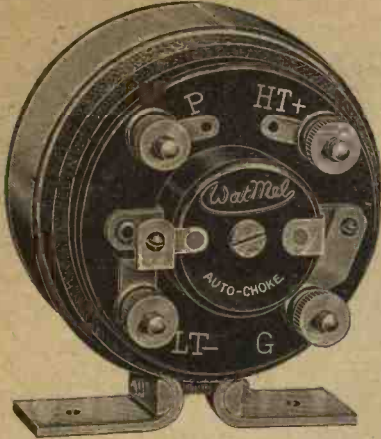

"...we might be in the studio..."

will be no uncommon remark now the Watmel Auto-Choke has come into being. This is not a choke in the ordinary sense, but an auto-Transformer coupled to the grid in a special manner and gives an amplification equal to the best transformer but with the purity of choke coupling. Ask your Dealer for a demonstration and send to us for descriptive booklet—"Straight as a die." Complete with condenser and fixed resistance. Price 18/6 Bright parts heavily nickelled.

Watmel AUTO-CHOKE

THE WATMEL WIRELESS CO. LTD
332a, Gcswell Road London, E.C.1
Telephone: 7990 CLERKENWELL.
Lancashire & Cheshire Representative:
Mr. J. B. LEVEE, 28, Hartley St., Levenshulme, Manchester
Telephone: 475 Heaton Moor

LUSTRALOX
WIRELESS VALVE REPAIRS
D.E. 7/-: B.E. 4/6: Power 10/-
Guaranteed: Prompt Despatch.
Write for Repair Lists.
Obtainable from LEWIS'S Ltd., Liverpool and Manchester, & LUSTROLOX Ltd., West Bollington, nr. Macclesfield.

EASY PAYMENTS We supply, by easy payments components, accessories and sets Any make. 10% down, balance spread over one year. Send list of requirements to **LONDON RADIO SUPPLY CO.** 11, Old Lane, London E.C.2. Phone, City 1977

Valves Repaired
AS GOOD AS NEW!!
Except Weco, S.F.'s, and low capacity types. Minimum D.E. Current 0-15 amps when repaired.
ALL BRIGHT & DULL EMITTERS Listed at less than 10/-.
MINIMUM CHARGE - 5/-
VALCO LTD. Dept. C., Tabor Grove, Wimbleton, S.W.

REPAIRS
By specialists skilled in every form of accurate and intricate coil winding.
Headphones, Loud Speakers and Transformers re-wound, remagnetised, and reconditioned **EQUAL TO NEW** and returned the same day on C.O.D. system. The unsolicited opinion of one of our many satisfied clients—"all I can say is, they are better than when new."
VARLEY Magnet Co.
Cable Dept.: Woolwich, S.E.18.
Proprietors: Oliver Poll Control Ltd.

APPARATUS TESTED—continued

C.A.V. Multiple Fixed Condenser

A CONDENSER unit capable of giving 14 different values of capacities according to the method of connection has been forwarded to us for examination by Messrs. C. A. Vandervell and Co., Ltd.

The unit is exceedingly neat in appearance, being circular in shape

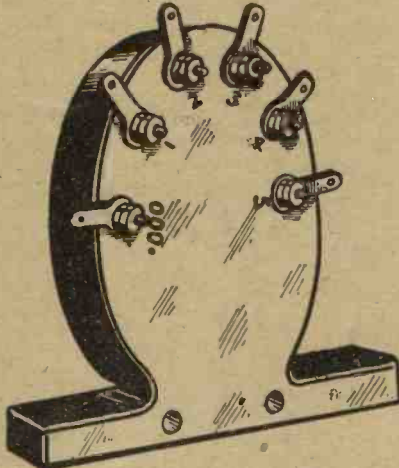

Fourteen different capacity values can be obtained with this C.A.V. multiple fixed condenser.

except for the fact that a base is provided so that the condenser may be screwed to a panel or baseboard either vertically or horizontally. The case containing the fixed condensers is manufactured from ebonite.

When using the component one terminal which is marked .000 always forms one connection, and the other connections may be taken to any of the points marked 1, 2, 3, 4 or 5, which will give a value of .0001, .0002, .0003, .0004 or .0005 respectively. If higher capacity values are required it is necessary to join the terminal No. 5 to any of the other terminals, and take the connection from either of the two so joined—thus 5 and 1 joined together will give a value of .0006. The sum of the numerals indicates the value. Both nuts and soldering tags are provided.

When tested at our Laboratories the capacities were found to be .0001, .00015, .0002, .0004 and .0005.

We should have liked to see the .0002 and .0003 condensers nearer to the rated value, but apart from this the component can be recommended for use.

Acfil Pumps

MESSRS. E. M. FRANCIS have submitted to us for test and report one of their Acfil pumps, which is specially designed for transferring acid from carboys direct to the accumulator.

It is claimed that this pump is fitted with a special expansion nozzle by means of which it may be fitted to

carboys with large or small necks. When tried on a carboy with an exceptionally small neck the fitting was somewhat on the large size, and it had to be held in position by hand when using the pump.

A rubber ball is fitted in the neck of the carboy and a knurled nut is screwed round on to it, expanding the rubber so as to grip tightly in the neck of the carboy. Through the centre of this rubber bulb passes a length of rubber tubing which goes to the bottom of the carboy. Pressure is built up by means of a rubber bulb, thus forcing the acid up the rubber tube, the acid then being delivered to any required point. It is claimed that a capacity of about two gallons per minute can be obtained, and this was found to be the case in actual practice. A clip on the end of the rubber tube allows the flow of acid to be started or stopped at will, and we can thoroughly recommend this pump for its particular purpose.

Toggle Switch

OUR Elstree Laboratories have examined one of the bakelite toggle switches forwarded by Messrs. The Rothermell Radio Corporation of Great Britain.

This switch is exceedingly neat and compact, consisting of a circular moulding of insulating material 1 1/2 in. in diameter. In the centre of this is a small cylindrical projection with a dome top to it which has a slot cut down its centre, and in this slot a small black insulated lever moves. The mechanism is neat and simple, and provides a quick break and a positive contact.

The actual resistance of the com-

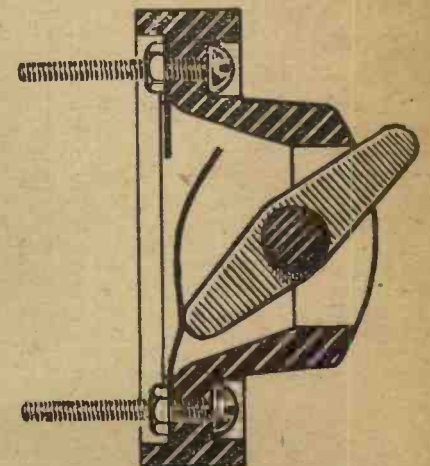

Neatness and compactness characterise the toggle switch of The Rothermell Radio Corporation of Great Britain.

ponent was measured and found to be negligible, and when in the off position the insulation resistance was infinity.

HOW TO WIND SPACED SINGLE-LAYER COILS

By W. H. FULLER

Several methods by which the constructor may space the turns on single-layer coils are described in this helpful constructional article.

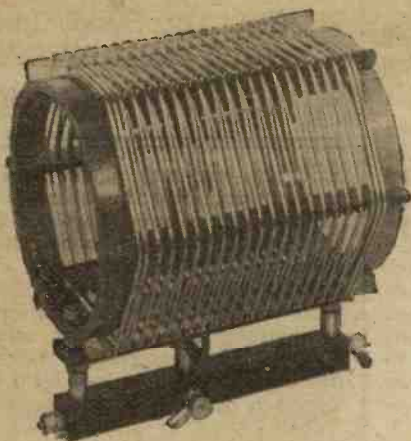

the most important being the reduction of self-capacity which exists between adjacent turns of the inductance. Another source of loss is the leakage from turn to turn due to faulty insulation, which may occur either in the covering of the wire or in the former upon which the wire is wound. This loss is more apparent when cotton-covered wires are used, and although this may be overcome by excluding moisture by doping with shellac, by so doing the dielectric loss is increased.

The ideal coil would be one wound with bare wire and supported by air, provided that the ratio of length to diameter was correct and none of the turns were short-circuited.

The Former to Use

The use of ordinary cardboard formers has now been practically dis-

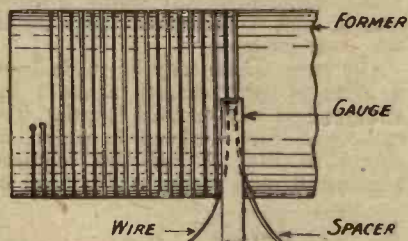

Fig. 2.—Both wire and spacer are fed through the small hole. For clearness the turns are shown well spaced, but actually they are wound close, the string being subsequently removed.

pensed with in favour of materials such as ebonite and Paxolin. The latter named material is, however, rather expensive, and is generally only used in very special cases, such as standard inductances. Thus perhaps the best thing the home constructor can use is ebonite, which can be obtained from many of the advertisers in this journal. Ebonite is not too expensive, and is not very difficult to work.

One of the most satisfactory methods of winding spaced coils is to have a threaded former, which can be purchased, or, in the case of lucky possessors of a lathe, made by cutting a thread on the ebonite tube mounted on a wooden mandril.

Suggested Winding Methods

When threaded formers are not available, the constructor may employ

one of the following methods, the simplest being to use a spacer of string or wire. Both the wire and the spacer should be secured to a screw fixed in the tube or passed through holes

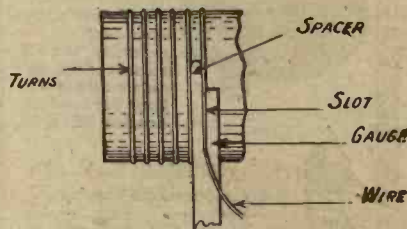
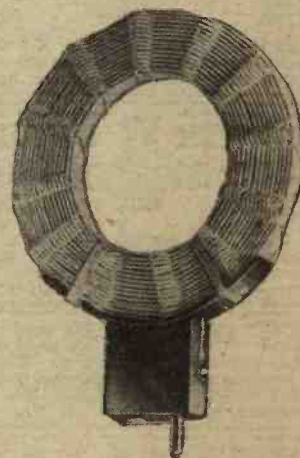

Fig. 3.—A gauge is suitable for winding spaced thick wire coils.

drilled in the tube. Both are then wound on the tube side by side as tightly as possible and close together to ensure uniformity of spacing.

A useful tool which may help in the winding of such a coil can be made from a piece of wood cut to the shape shown in Fig. 1. A small hole is drilled through the head of the tool, just large enough to pass both leads. With the help of this tool it is possible to pull the wire tight and to keep the spacing correct, and with the aid of Fig. 2, which shows how the gadget is used, no difficulty should be encountered in winding such a coil. When



Multi-layer plug-in coils still have many advantages which render their use popular.

the end of the coil has been secured the spacer may then be unwound.

FOR some considerable time plug-in coils have been universally used in every type of receiving set, but of late there has been a tendency to return to the single-layer type of inductance, which was very popular at the beginning of broadcasting, especially with crystal set designers. Hitherto the size of single-layer coils was due generally to the large gauge of wire used, but it has been found that by suitably spacing the turns of wire from each other and using a much finer gauge of wire, thus reducing the size of the complete inductance, equally efficient coils may be produced, and in many cases more efficient than the old-fashioned cardboard former type.

It does not necessarily mean that the finer the gauge of wire used the more efficient will be the inductance. This is not so, as various other considerations have an important bearing on the efficiency. Readers are referred to some of the articles by Mr. J. H. Reyner on coils which have appeared in Radio Press journals from time to time.

An Interesting Coil

Digressing for a moment, it may be of interest to readers to know that one of the most efficient inductances yet measured at the Elstree Laboratories

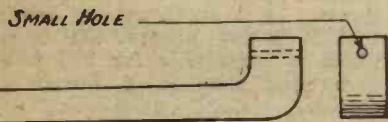

Fig. 1.—This simple tool is useful for winding spaced coils.

is wound with No. 22 d.s.c. wire, spaced 20 turns to the inch on a 6-in. Paxolin former. This coil was made by the writer for a Hartley oscillator, and has a resistance of .028 ohms per micro-henry.

Why the Turns are Spaced

The losses which may be overcome by spacing the turns of a coil are various,

TRIX

Lever Pattern Switch is one-hole fixing, and it has an on-off indicating plate. No. 264. 1/6. Also push-pull switches, one, two, and five way.
Eric J. LEVER
 33, Clerkenwell Gr., London, E.C.1, and Branches.

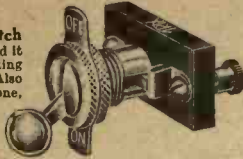

Anodon RHEOSTATS



THE Rheostat which ensures fine adjustment of current to filament saves the life of your valves and enables you to enjoy the full volume of possible reproduction. Your Set needs an Anodon Rheostat.



With solid Bakelite Knob ... 3/9
 With cold-moulded Tapered Knob ... 2/6
 The Anodon Coil with its unique plug and perfect insulation leaves no loophole for H.F. losses, and because of its low self-capacity, covers an unusually wide band of wavelengths.
 Size 50 ... Price 3/- each.
 Special 2 Megohm Hard Rubber Grid Leak ... Price 1/8 each.

Anodon

If your local dealer is out of stock send to Anodon, 72-88 Oxford Street, W.1, enclosing P.O. for price quoted and the article will be delivered by return, post free.

HOW TO WIND SPACED SINGLE-LAYER COILS—continued

Using a Gauge

Another method which has been used by the writer with fairly stout conductors is to employ a gauge. The gauge is made from either wood or ebonite, and is cut to shape as shown in Fig. 3. The gauge is held in the hand and is pressed against the preceding turn, while the wire is fed over the small cut in the head of the gauge. This method can only be employed when large wires are used, owing to the fact that the pressure is liable to displace the turns already wound.

For Small Wires

This may be overcome when small wires are being wound by a device

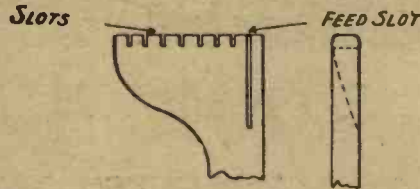

Fig. 4.—The "turn-chaser" referred to is very simply made.

which may be called a turn chaser. It is not unlike an ordinary thread chaser, consisting as it does of a number of small teeth of a fixed pitch, which engage in the turns already wound, and so advances the wire in the same manner.

The turn chaser may be made from a piece of 1/4-in. ebonite about 1 in. wide and of any suitable length. The ebonite is first filed up to shape, as shown in Fig. 4, and the required number of slots made in the head of

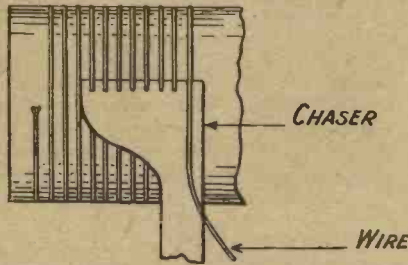

Fig. 5.—The employment of the chaser ensures even spacing throughout the length of the coil.

the tool with a fretsaw blade. The right-hand slot may be cut deeper than the others, as the wire is fed through this slot.

First secure the end of the wire to the former and make one complete turn round it and catch the wire in the right-hand slot. When this is done engage the beginning of the first turn in the second slot and make another turn. Continue winding, keeping all the slots in register, the tension of the wire being controlled by pressing the wire against the chaser with the thumb.

MAKING THE BEST USE OF YOUR ENVIRONMENT.

(Concluded from page 888.)

using an ordinary earth lead to a water pipe. This, however, will often provide only a very short aerial, even if the wire is run round the room away from the walls.

It is always advisable to keep the wire away from the walls, even if this means sacrificing a certain amount of length. The material of which walls are constructed does not form by any means a good di-electric, and appreciable losses may occur if the wire is fixed close to them. For the local station the aerial may prove all right, but for more distant work it will hardly be successful, unless a very sensitive receiver is used.

Further Examples

A long passage gives an admirable opportunity of putting up a good indoor aerial. Either one or two wires may be slung along the length of it, a foot or two below the ceiling and midway between the side walls. If the room where the receiver is situated is not at one end of the aerial, it will be necessary to determine by experiment the best point at which to attach the lead-in to the horizontal wire.

A staircase provides another "opening" for an aerial. The wire in this case may be stretched from top to bottom of the stairs, straight down in the "well" between the banisters. This will, of course, be most suitable when the receiver is in a room on the ground floor. The writer has also heard of excellent results being obtained by stretching a wire down the lift shaft of a high block of flats.

Suiting Your Own Conditions

It is obviously impossible to lay down definite rules for the disposition of aerial systems, simply because one or other of them has to be violated in almost every individual case to suit peculiar conditions or special requirements. It is worth noting, however, that it is not always the receiver which is responsible for bad results, even quite close to a broadcasting station.

The Deciding Factor

An error into which a number of people are prone to fall is that of supposing that it is worth while to make use of a highly sensitive receiver, without paying enough attention to the aerial system on which it is to be used. Possibly the receiver will give good results on a poor aerial system, but this is no argument for the use of such a system, so long as anything better can be arranged with the exercise of a little ingenuity.

THE STARS OF VALVE ECONOMY

Great Selectivity Distortionless Amplification Loud Speaker Volume

9 **9** **11**

2Y .06 HF 2Y .06 LF 2Y .34 PV

Obtainable from Lesci's, Ltd., Liverpool and Manchester, and LUSTROLUX LTD., West Bollington, near Macclesfield.

EBONITE BUSHES

FOR MOUNTING ON WOOD. PERFECT INSULATION.

Orders under 1/- send 1/4d. Postage. Two required for each hole.

NUMBER	0	1	2	3	4	5	6
Hole in Bush...	6BA, 4BA, 2BA.	1/4"	5/16"	3/8"	7/10"		
Price each:	1d.	1d.	1d.	1 1/2d.	2d.	2d.	2d.

DAREX RADIO CO.,
 Waldram Road, Forest Hill, London, S.E.23

FREE OFFER.—We build any set designed by the Radio Press at the cost of the components only. Absolutely no charge for constructing. This offer ends on Sept. 1st. **LONDON RADIO SUPPLY COMPANY, 11, Oat Lane, London, E.C.2.** Phone: City 1977.

WIRELESS

Capable, trustworthy men with spare time who wish to substantially increase income required where we are not fully represented. Applicants must have practical knowledge of installation of Set and Aerial, be a Householder or live with parents, and be able to give references; state age and experience. Address Dept. 22, **GENERAL RADIO COMPANY LIMITED,** Radio House, Regent Street, LONDON, W.1.



GREAT BOOM NUMBER

The Special WIRELESS Amplifier Number now on sale shows you how to obtain loud-speaker results

THIS is the day of the loud-speaker. In addition to many other attractive and interesting features the issue of WIRELESS dated July 17th—now on sale—contains, under the following titles, full constructional details of three efficient Valve Amplifiers incorporating many modern improvements in design :

The WIRELESS Transformer Amplifier

The WIRELESS Choke Amplifier

The WIRELESS Resistance Amplifier

The authors have very successfully described the three Amplifiers so that every possessor of a crystal set—either commercially or home-constructed—can, without difficulty of any kind, build one of these WIRELESS BOOM NUMBER AMPLIFIERS and obtain pleasing loud-speaker results.

The efforts of the Editors and Authors are well rewarded since this issue is of great and absorbing interest. Every crystal listener will buy a copy to read how the pleasures of loud-speaker reproduction are so easily obtainable.

Be sure you buy your copy to-day. It will help you to make your wireless receiver a greater pleasure

WIRELESS
 INCORPORATING
WIRELESS WEEKLY **2^D**
WEEKLY

Obtainable from all Newsagents, Book-stalls and Book-sellers, or direct from the Publishers, Radio Press, Ltd., Bush House, Strand, London, W.C.2. Subscription Rates, 13/- per annum throughout the world.

INDEX TO ADVERTISERS.

	PAGE
Anodon, Ltd.	958
Artaft Company (The) ...	954
Ashley Wireless Telephone Co., Ltd.	954
Bedford Electrical & Radio Co., Ltd.	952
Benjamin Electric Co.	926
Bird (Sydney S.)	911
Bowyer-Lowe Co., Ltd.	877
British Engineering Products Co.	938
Burne-Jones & Co., Ltd.	952
Cahill & Co., Ltd.	954
Carrington Mfg. Co., Ltd.	938
Caxton Wood Turnery Co.	911
Cleartron Radio, Ltd.	937
Collinson Precision Screw Co.	938
Cossor (A. C.), Ltd.	897
Darex Radio Co.	953
Dubilier Condenser Co. (1925), Ltd.	951
Electron Co., Ltd.	949
Falk, Stadelmann & Co., Ltd.	899
Ferranti, Ltd.	876
Finston Mfg. Co., Ltd.	900
Forno Co.	900

	PAGE
Gambrell Bros., Ltd.	952
Garnett, Whiteley & Co., Ltd.	908, 952
General Radio Co., Ltd.	958
Hughes (F. A.) & Co., Ltd.	908
Igranic Electric Co., Ltd.	911
Jackson Bros.	899
Lever, Eric J.	952, 958, 960
Lissen, Ltd.	941

	PAGE
London Electric Wire Co. & Smiths, Ltd.	900
London Radio Supply Co., Ltd.	956, 958
Lustrolux, Ltd.	956, 958
M.A.P. Co.	960
M. & A. W.	900
Metro-Vick Supplies, Ltd.	935, 951
Mullard Wireless Service Co., Ltd.	Cover ii
Newnes (Geo.), Ltd.	899
Oldham & Son, Ltd.	904
Peto-Scott Co., Ltd.	947
Portable Utilities Co., Ltd.	930
Pye (W. G.) & Co.	949
Radiax, Ltd.	952
Radio Instruments, Ltd.	Cover iv
Raymond (K.)	908
Rectalloy, Ltd.	960
Telegraph Condenser Co., Ltd.	900
Valco, Ltd.	956
Vandervell (C. A.) & Co., Ltd.	928
Varley Magnet Co.	956
Watmel Wireless Co., Ltd.	956
Wright & Weaire	935

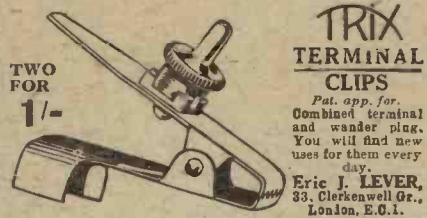

Now you can Charge your H.T. Accumulator at home!



WITH the Rectalloy Charger shown above you can keep your high tension accumulator fully charged at practically no cost from your a.c. mains. It will charge any high tension accumulator up to 90 volts. in the normal series arrangement. It takes very little

entirely new and patented method. No need to carry heavy accumulators to the charging station and wait while they are charged (and perhaps ruined). Install a Rectalloy and leave it to do its work satisfactorily and well. The charging rate is automatically governed so that a 20 or 90 volt H. T. Accumulator receives practically the same charge. An extremely neat charge-indicator and excess-current fuse is incorporated, making the apparatus fool-proof and trustworthy.

47/6
For a.c. only, 200-250 volts, 40-60 cycles

RECTALLOY
The ideal battery charger

Send at once for full particulars and explanatory Folder 'P.S.' post free.

Rectalloy Ltd., Vulcan House, Ludgate Hill, London, E.C.4.

COUPON

Questions and Answers

This Coupon must be accompanied with a 2/6 P.O. and Stamped Addressed Envelope.

"WIRELESS CONSTRUCTOR"

August, 1926.

FREE BLUEPRINT SERVICE

COUPON

Wireless Constructor, Vol. II No. 10, August, 1926

This coupon entitles the reader to one back-of-panel blueprint of any set described in the above issue, and must accompany each postal application.

G.A. 5439.

In replying to advertisers, please mention THE WIRELESS CONSTRUCTOR.



Afternoon Reception of Cardiff and Manchester on a Frame

MR. HARRIS has so designed this handsome Eight-Valve Super-Heterodyne Receiver to contain only the most highly efficient features which British and American designs have produced. Two years' close study—both in this Country and in the States—enable the author to give the readers of MODERN WIRELESS constructional details of an extremely reliable Super-Heterodyne in an article happily named "All Europe on a Frame."

Such characteristics as simplicity of operation; particularly sharp tuning; high quality of reproduction; a pleasing and compact appearance and economy of operation (a very important point!) must be added to that of the surprising ease with which Stations all over Europe may be tuned in from a previous calibration.

A further important article—"Operating the Elstree Six"—appears in this issue on the star receiver now creating so phenomenal an interest throughout the country by virtue of its great achievement in receiving sixty stations on the loud-speaker in one hour.

Read this short interesting list; it gives the principal contents for the July issue:

- All Europe on a Frame Aerial.
By Percy W. Harris, M.I.R.E.
- Operating the Elstree Six.
Described by J. H. Keyner, B.Sc. (Hons.)
A.O.G.I., D.I.C., A.M.I.E.E.
- How British Broadcasting is Received on the Continent.
By Captain L. F. Plugge, B.Sc., F.R.Ae.S.
F.R.Met.S.
- The "Riverside Four."
By D. J. S. Hart, B.Sc.
- Circuits for Sharp Tuning.
By E. M. Mason.
- A Chat About "Local Conditions."
By Stanley G. Raltee, M.I.R.E.
- My Home Set.
By John Underdown.
- Calibrating Your Receiver.
By Capt. H. J. Round, M.C., M.I.E.E.
- Some Notes on 45-metre Transmission.
By R. W. H. Blozam (5L9).
- Split Coil Circuits with Ordinary Coils.
By W. G. Kay.
- Regular Programmes from Continental Broadcasting Stations.
- Progressive Frequency Transformers.
By J. H. Kemner, B.Sc. (Hons.), A.M.I.E.E.
- Elstree's Artificial 2F.O.

One Shilling
MONTHLY

**Modern
Wireless**

On Sale July 1st

Obtainable from all News-agents, Booksellers, or Bookstalls, or direct from the Publishers.

Subscription Rates 15/- per annum (13/6 per annum Canada & Newfoundland). Lesser periods *pro rata*.

RADIO PRESS LTD., BUSH HOUSE, STRAND, LONDON, W.C.2

For Every Valve



THE R.I. Multi-Ratio Transformer will operate at maximum efficiency with any type of valve. The wide range of impedance values available ensures perfect results, because a suitable impedance can always be found for the valve in use. Only by using this transformer can you be assured of the finest reception.

Price
27/6

We have received hundreds of letters testifying to the wonderful results obtained, and the entire elimination of distortion. Perhaps yours is amongst them.

This transformer solves all the difficulties experienced by most amateur constructors. It greatly simplifies the construction of valve amplifiers. Incorporated in your set, it will at once prove its superiority.

Ratio Table	
1	— 1
1½	— 1
2	— 1
3	— 1
4½	— 1
6	— 1
9	— 1

Its great advantages, backed by the fine workmanship that is behind all R.I. products, will give you assurance of complete success.

Write for the
*R.I. Blue and Gold
Catalogue.*



THE MARK OF BETTER RADIO

Advt. R.I. Ltd., 12, Hyde Street, New Oxford Street, London, W.C.1.



PC 34